



# 2025 EXPO

## MARCH 25-27

DENNY SANFORD  
PREMIER CENTER  
SIOUX FALLS  
SOUTH DAKOTA

### -WHAT'S INSIDE-

EXHIBITOR GUIDE

SHOW SCHEDULE

SPONSORED EVENT DETAILS

Welcome Reception, Free Breakfasts,  
Wine & Cheese Social & more!

MEET RAELYNN!

BREAKOUT SESSIONS

ED SHED SCHEDULE

ACCESS INDUSTRY EXPERTS

NEW PRODUCT SHOWCASE

WELCOME  
RECEPTION

TUESDAY,  
MARCH 25

Featuring Country  
Music Star



# RaeLynn

Register online

[CENTRALPLAINSDAIRY.COM](http://CENTRALPLAINSDAIRY.COM)

*Excellence In Dairy Video Marketing*



*Dairy Video Sales*

# **MONTHLY DAIRY VIDEO SALE**

**SELLING LOADS & HALF LOAD LOTS OF TOP QUALITY  
DAIRY CATTLE FROM  
COAST TO COAST - BORDER TO BORDER!**

**LOOKING TO  
BUY,  
SELL,  
OR DISPERSE?  
WE CAN HELP!**

**COME SEE US... BOOTH C124!**

**REPRESENTATIVES ALL OVER THE U.S.  
LIVE BROADCAST & ONLINE BIDDING AVAILABLE**

**209.633.8146 ~ 209.262.4019**

**WWW.TLAYDAIRYVIDEOSALES.COM**



# DMI

**DIESEL MACHINERY INC.**

**VISIT US AT THIS  
YEAR'S SHOW!**



## 3 DIESEL MACHINERY LOCATIONS

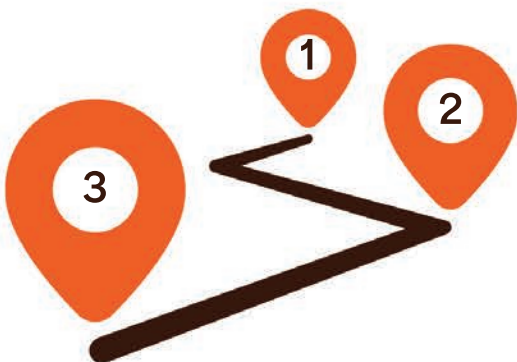

Sioux Falls (605) 336-0411  
4301 N Cliff Ave | Sioux Falls, SD

Aberdeen (605) 725-4364  
39288 133rd St, East Hwy 12 | Aberdeen, SD

Rapid City (605) 348-7438  
3801 N Deadwood Ave | Rapid City, SD

**SALES • SERVICE • PARTS • RENTALS**  
**DIESELMACHINERY.COM**

# WELCOME TO THE 2025 EXPO

The Central Plains Dairy Expo is not just about business; it's also about community. From the Welcome Reception featuring live entertainment to the free prayer breakfast and social events, the Expo fosters a spirit of camaraderie and celebration among dairy professionals. You are invited to take part in fun, relaxing events that complement the Expo's educational offerings.

As we look forward to the 2025 Central Plains Dairy Expo, it is an honor for me to serve as president of the Central Plains Dairy Association. This year's Expo promises to be one of the most exciting yet, as we come together to celebrate the strength and innovation of the dairy industry.



*Tom Walsh*

We are living in a time of change – changes in consumer demand, advancements in technology and evolving regulations. But one thing remains constant: the determination and resilience of dairy farmers. This year's Expo will showcase the very best of our industry, with more than 300 exhibitors offering cutting-edge products, services and technologies designed to enhance our operations and improve sustainability.

I encourage each of you to take advantage of the wealth of knowledge that will be shared throughout the Expo. From the educational sessions to networking opportunities, this event provides a platform for all of us to learn, grow and connect with one another. The challenges we face may be great, but together, we can ensure a bright and prosperous future for dairy in the Central Plains and beyond.

I look forward to welcoming you to the Expo, where we can reflect on our shared past, celebrate our current achievements and build the foundation for the dairy industry's continued success.

See you in March!

Tom Walsh  
President, Central Plains Dairy Association

# CONTENTS

- ▶ Schedule & Registration  
PAGE 7
- ▶ Welcome Reception  
PAGE 8
- ▶ Ag Prayer Breakfast  
PAGE 12
- ▶ CPDF Scholarships  
PAGE 14
- ▶ Breakout Sessions  
PAGE 16
- ▶ Wine & Cheese Social  
PAGE 26
- ▶ Pancake Breakfast  
*sponsored by Agropur*  
PAGE 41
- ▶ Free Donuts  
*sponsored by MGK, Vaxxinova, Morning Ag Clips  
& BouMatic*  
PAGE 59
- ▶ Breakout Sessions in Spanish  
PAGE 62
- ▶ Annual Golf Outing  
PAGE 68
- ▶ ED (Education) Shed  
PAGE 70
- ▶ Sponsored Food Events  
PAGE 75
- ▶ New Product Showcase  
PAGE 78
- ▶ Lodging & Convention Center  
PAGE 90
- ▶ Star Sponsors  
PAGE 92
- ▶ Exhibitor List  
PAGE 98
- ▶ Convention Center & Arena Map  
PAGE 102

## Board Members

### TOM WALSH

Riverview Dairy, President

### EVAN GRONG

Valley Queen Cheese Factory, Vice President

### KARI JUNGEMANN

Lazy J Dairy LLC, Secretary/Treasurer

### MICHAEL REECY

Farm Credit Services of America

### STACIE DE GROOT

Gorter's Clay & Dairy Equipment Inc.

### JENNIFER LANDMAN

Linde Dairy, LLC

### AARON TITTERINGTON

Jones Dairy

### BARRY VISSER

Vita Plus

### RICK EGGBRECHT

Novita

### ERIN MAROTZ

En-Mar Holsteins & TLAY Dairy  
Video Sales



# YOUR TRUSTED PARTNER IN ANIMAL HEALTH



Sheldon Staff



Carroll Staff

ANIMAL PHARMACY RX

- ✓ *High-Quality Supplies* for dairy, beef, swine & more.
- ✓ *Competitive Pricing* to keep your costs in check.
- ✓ *On-Farm Delivery* for unbeatable convenience.

## SHOP FROM POPULAR BRANDS



We partner with the industry leading brands above & more, to bring you trusted products that deliver results!

### ARE YOU WITHIN OUR SERVICE AREA? REACH OUT TODAY!

712.324.7000 | SHELDON, IA • 712.775.3000 | CARROLL, IA

[www.deluxeanimalhealth.com](http://www.deluxeanimalhealth.com)

# SCHEDULE AT-A-GLANCE

## TUESDAY, MARCH 25

5:00 PM	DOORS OPEN WELCOME RECEPTION INCLUDES CENTRAL PLAINS DAIRY APPETIZERS & ENTERTAINMENT BY RAELENN
9:00 PM	SHERATON HOSPITALITY ROOM

## WEDNESDAY, MARCH 26

6:30 AM	AG PRAYER BREAKFAST - DOORS OPEN
8:30 AM	TRADE SHOW OPENS
8:30 AM	FREE DONUTS
11:00 AM - 4:30 PM	BEER GARDEN OPEN
9:00 AM - 5:00 PM	BREAKOUT SESSIONS
9:00 AM - 5:00 PM	BREAKOUT SESSIONS IN SPANISH
11:00 AM	FREE GRILLED CHEESE SANDWICHES
11:30 AM	DAIRY GIRL NETWORK LUNCHEON
2:00 PM	FREE ICE CREAM
4:30 PM	WINE & CHEESE SOCIAL
5:30 PM	TRADE SHOW CLOSES

## THURSDAY, MARCH 27

8:00 AM	TRADE SHOW OPENS
8:00 AM - 10:00 AM	FREE PANCAKE BREAKFAST
8:00 AM - 3:00 PM	BREAKOUT SESSIONS
8:00 AM - 3:00 PM	BREAKOUT SESSIONS IN SPANISH
11:00 AM - 3:00 PM	BEER GARDEN OPEN
11:00 AM	FREE GRILLED CHEESE SANDWICHES
1:00 PM	FREE ICE CREAM
3:00 PM	TRADE SHOW CLOSES

## ONLINE REGISTRATION, MOBILE APP, KIOSK CHECK-IN, AND MORE . . .

The Central Plains Dairy Expo (CPDE) remains free to attend. However, you need a badge to enter all activities and events.

### ▶ PRE-REGISTER ONLINE

Registration to attend the 2025 Expo is available **ONLINE!** To make in-person check-in fast and easy, simply register online at: [www.centralplainsdairy.com](http://www.centralplainsdairy.com)

### ▶ ON-SITE REGISTRATION

We will have registration available on-site as well.

### ▶ NAME BADGES

Instead of standing in line for your printed badge, you will walk right up to a kiosk at the event, enter your name and, if you are pre-registered, your badge will print right away for you. This registration system applies to visitors and exhibitors.

### ▶ MOBILE APP

Download the app today so you don't miss events and exciting offers at the Expo!

[www.centralplainsdairy.com](http://www.centralplainsdairy.com)



DOWNLOAD THE  
CVENT EVENTS  
MOBILE APP

STAY UP TO DATE ON THE LATEST EXPO NEWS,  
ACTIVITIES, SESSIONS, EVENTS & MORE!

Search for "Cvent Events" in your app store.



# Welcome Reception

Tuesday, March 25

# RaeLynn

## RaeLynn to Headline CPDE Concert: A Night of Country Music and Celebration

Country music sensation RaeLynn will take the stage at the Central Plains Dairy Expo concert on March 25, at the Denny Sanford Premier Center in Sioux Falls, SD. This highly anticipated performance marks a highlight of the Expo, where attendees will experience an unforgettable evening with one of the most vibrant stars in country music today.

A two-time ACM New Female Vocalist nominee, RaeLynn has captured hearts with her signature blend of emotional storytelling and bold, magnetic personality. Known for her distinct voice and relatable lyrics, she's made waves with hits like "God Made Girls" (Platinum-certified), "Love Triangle" (Gold), and her latest release, "Funny Girl," which marks a new chapter in her evolving career. With more than 2.8 million social media followers and more than 1 billion career streams, RaeLynn is a true force in the industry.

The CPDE concert kicks off at 7 p.m., but the evening's festivities start earlier with the CPDE Welcome Reception at 5 p.m. – a free, must-attend event for all dairy producers. Guests will enjoy hearty appetizers, 800 pounds of cheese served charcuterie style, and a variety of delicious ice cream flavors to keep things sweet before RaeLynn's performance. The Welcome Reception offers a perfect opportunity for attendees to network, relax, and indulge in a variety of tasty treats before the main event.

RaeLynn's performance at CPDE promises to be an unforgettable night of music, fun, and celebration. With her unique blend of country charm and authenticity, she's sure to deliver a concert that resonates deeply with fans old and new. Whether you're a longtime supporter of RaeLynn or discovering her music for the first time, this concert is a night you won't want to miss.



# WELCOME RECEPTION

**DOORS OPEN:** Doors open to the Denny Sanford Premier Center at 5:00 p.m.

**FREE TICKETS:** Tickets to the Welcome Reception and entertainment are free for producers. However, registration is required. Visit [www.centralplainsdairy.com/registration](http://www.centralplainsdairy.com/registration) to pre-register for your name badge.

**ON THE MENU:** Join us early for heavy appetizers, cheese charcuteries and a large variety of ice cream flavors - all for free at the Welcome Reception. Thank you to our cheese and dairy donors AMPI, Valley Queen Cheese Factory, Agropur, and Prairie Farms.

## Thank you to our Sponsors



**FARM CREDIT**

Micro Technologies™  
AmerisourceBergen



CENTRAL PLAINS DAIRY EXPO

# AFTER



# PARTY

**HOSPITALITY ROOM**

FOLLOWING THE CPDE WELCOME RECEPTION!



8:00PM- 12:30AM

**TUESDAY  
MARCH 25, 2025**



SHERATON HOTEL  
FONTENELLE ROOM

SPONSORED BY:



2025 NMC Regional Meeting

# SAVE THE DATE

July 22-24 | Hyatt Regency | Rochester, New York, USA



**This meeting provides a forum for networking and sharing information about udder health, animal health and welfare, milk quality and milk safety.**



**NMCONLINE.ORG**

PRODUCTS | LAB TESTING | SERVICES



Division of 



**We have everything you need:**  
**Antibiotics | Calf Supplies | Hoof Care**  
**Pest Control | Vaccines**

The options are endless from your major manufacturers through Armor Animal Health.

**VISIT US AT CPDE BOOTH #C228!**

**800.255.1181 | [ArmorAnimalHealth.com](http://ArmorAnimalHealth.com)**

©2025 Armor Animal Health®



**BUILT STRONGER.  
LASTS LONGER.**

Specialized equipment built stronger to execute your agricultural waste handling needs.

**Screw Separators**



**Prop Mixers**

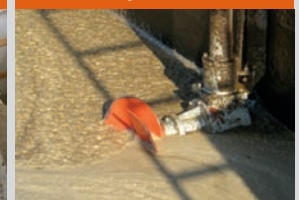

**Chopper Pumps**



**Sludge Thickeners**

SALES > SERVICE > TRADE-INS

Ask us about our free 30-day equipment trial.

**507.375.5577**  
**dodausa.com**

255 16th Street South, St. James, MN



# AG PRAYER BREAKFAST



*Rob Roozeboom*

Wednesday, March 26 in the Premier Center:  
Doors open at 6:30 a.m.

Get ready to be inspired at this year's Central Plains Dairy Expo Prayer Breakfast as Rob Roozeboom - a Jesus-follower, husband, dad, evangelist, speaker, podcaster and author - shares his broken - still chosen - journey. His passion is to inspire people to find hope and worth amidst brokenness.

As a young child, Rob dreamt of becoming an athlete and farmer. A muscular dystrophy diagnosis at age 5 crushed those dreams. Feeling painfully different and forgotten, Rob questioned his very existence and wrestled with God about his future. God had bigger dreams for Rob.

In 2001, Rob founded RISE Ministries, Inc. and in 2005 he launched RiseFest, an annual Christian music festival in Northwest Iowa that features some of the nation's top Christian artists and speakers.

Living with muscular dystrophy has given Rob a unique and relatable perspective on walking through adversity while holding onto faith. His authenticity connects with and encourages people from all walks of life. He's a sought-after speaker who shares his story and delivers Jesus' message of hope to communities, businesses and prominent events nationwide. He's shared the stage with Phil Wickham, For King & Country, TobyMac, Skillet, Lecrae, Anne Wilson, Jep Robertson, Megan Fate Marshman and Darryl Strawberry.

## Thank you to our Ag Prayer Breakfast Sponsors



Plymouth Dairy



balchem



Wieringa Seed Co



In 2022, Rob and the RISE team created *RISE with Rob & Friends* to bring singer-songwriters together for storytelling and music. Inspired by Nashville "Writers' Rounds," artists perform their original songs and share how they were inspired. Through this "night of hope through storytelling and music," Rob shares the gospel message with thousands of people in Iowa, South Dakota and Minnesota.

Rob also serves as the Christian Festival Association chairman, hosts the podcast "Enjoying the Journey" and produces annual Christmas and Easter TV programs, and "Stories of Strength," a video series with real-life stories of overcoming adversity through Jesus.



With special musical guest, Ellie Warring

Recently, Rob wrote his first book, "Broken Still Chosen." The book weaves Rob's inspiring story with biblical teaching - offering hope to those who feel broken, unloved, unseen or forgotten.

Additionally, Rob has received numerous humanitarian awards and has been featured multiple times on the National Jerry Lewis MDA Telethon. He and his wife live in northwest Iowa, with their three young adult children.

Set your wake-up alarm now! You won't want to miss Rob's inspirational messages.



# SCHOLARSHIPS

## CPDF's Scholarships: Investing in the Future of Dairy and Agriculture



The Central Plains Dairy Foundation (CPDF) is doing more than just offering scholarships; it's also shaping the dairy industry's future in the Central Plains region. This year, CPDF is expanding its reach and commitment to agricultural education with exciting scholarship opportunities for students passionate about shaping the future of dairy farming.

CPDF is proud to continue its legacy of fostering future leaders in agriculture with two groundbreaking scholarship programs, which are designed to invest directly in students who will shape the dairy industry's future. One of the foundation's goals is to strengthen the dairy community's "heart" in Iowa, Minnesota, Nebraska, North Dakota, South Dakota and Wisconsin.

### Lon and Kathy Tonneson Scholarship

The \$500 Lon and Kathy Tonneson Scholarship honors the legacy of Lon and Kathy Tonneson – two individuals who have dedicated their lives to agriculture and community service. Open to students who have completed at least one semester of post-secondary education in agriculture, with a focus on ag communications or leadership, this scholarship is a vital part of CPDF's investment in tomorrow's agricultural leaders. This scholarship typically launches about Dec. 1.

Why does it matter? As the dairy industry faces evolving challenges – from market shifts to technological innovation – the need for strong leadership and communication skills has never been greater. The Tonneson Scholarship equips young students with the tools they need to thrive in these areas and drive the industry forward.

### New CPDF \$5,000 scholarships

In addition to the Tonneson Scholarship, CPDF is making an even bolder move this year by introducing three \$5,000 scholarships aimed at students pursuing a two- or four-year degree focused on the dairy industry. This isn't just a scholarship; it's an investment in the future of the entire dairy sector. Look for scholarship application details starting Dec. 1.

# A foundation focused on dairy industry excellence

Kristy Mach, Central Plains Dairy Foundation executive director, sums it up perfectly:

***“Higher education is the foundation for continuous learning – one of CPDF’s cornerstones. By offering these scholarships, we are not just supporting students; we’re making an investment in the people who will drive the future of dairy farming.”***

The CPDF scholarship program is more than just a financial contribution; it’s about creating opportunities for students to develop the skills needed to navigate an evolving industry. Whether it’s through communication, leadership or technical expertise, these scholarships ensure that the future of dairy in the Central Plains is in capable hands.

In an industry that’s constantly changing, CPDF is leading the charge to ensure that future dairy professionals have the knowledge, skills and leadership abilities to meet tomorrow’s challenges – and that’s something every dairy farmer and industry professional can get behind. Don’t miss this opportunity to support the next generation of dairy leaders by supporting the Central Plains Dairy Foundation.

To make a contribution to CPDF, send a check – payable to the Central Plains Dairy Foundation – to 126 West Main Street, New Prague, MN 56071.

In addition, you can support CPDF by participating in CPDF’s annual fundraiser – Grazing on the Greens – set for July 30, at Rocky Run Golf Course, Dell Rapids, ShhD. Registration opens March 1. Find more details about participating and/or sponsoring this event at: <https://www.centralplainsdairy.com/golf-outing>.

***“Grazing on the Greens” annual golf outing.***



# BREAKOUT SESSIONS

## Navigating Uncertainty:

SPONSORED BY:  **TRANSITION POINT**  
BUSINESS ADVISORS



CENTRAL PLAINS DAIRY EXPO FUTURE CONNECTIONS

### Session Description:

In the face of change, whether managing a business succession, family transition or other pivotal shifts, producers often find themselves overwhelmed by uncertainty. The weight of balancing family dynamics, team management and business continuity can feel isolating and daunting. Rena Striegel, an expert in transition planning, will share insights on how families can embrace change with clarity and confidence. By focusing on setting clear goals, improving decision-making and fostering communication, one can achieve a better life balance. Striegel will share steps you can take now to start moving through the complexities of transition. This session will provide practical strategies for reducing stress and increasing your ability to lead with certainty - helping you and your family navigate this critical phase with a fresh perspective and unwavering support.

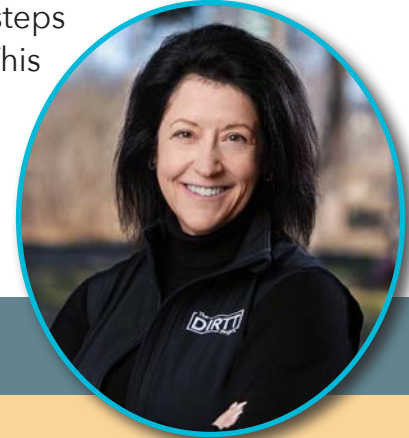

### Meet the Presenter: Rena Striegel

*President | Transition Point Business Advisors*

Rena Striegel, creator of The DIRTT Project, is an internationally recognized business coach and consultant with more than 20 years of experience working directly with farmers, ag leaders, senior executives and entrepreneurs to identify and implement strategies that create growth and profitability. As president of Transition Point Business Advisors, she leads client projects in strategic planning, business succession, continuity planning and employee/leadership development. Her talent lies in helping business owners and executives make connections between concepts and applications to help them achieve the level of operational excellence that allows resources to be focused on growth and transition, rather than fixing problems. Her direct and honest bottom-line approach has helped the leaders and management teams of farms and agribusinesses across the United States develop and implement plans for transition while improving their overall performance through clear, executable strategies and higher employee contribution. Her practical and often humorous approach to leadership makes her a sought-after keynote speaker at conferences. Striegel grew up on a dairy and hog farm in What Cheer, Iowa. She is a certified business coach and holds an MBA from the University of Iowa. In addition to her hands-on work with business owners, she hosts the Ag Inspo podcast and is a frequent contributor in farming publications, such as Top Producer magazine, Progressive Forage, Farm Journal and Cattle Business Weekly.



# BREAKOUT SESSIONS

## Avian Influenza:

### Protecting Farms and Industry in the Face of HPAI Threats

#### Session Description:

Join a dynamic panel discussion, moderated by Matt Hille, as state veterinarians provide critical updates on the ongoing fight against highly pathogenic avian influenza (HPAI). This session will cover the latest developments - from understanding how the virus spreads, including when it's not directly linked to birds - to where we stand with vaccine advancements. Learn why biosecurity is crucial for both personal and industry-wide protection, and explore practical measures to safeguard your farm. The panel will also dive into Centers for Disease Control and Prevention regulations, realistic protocols and the essential testing practices being implemented. Whether you're on a dairy farm or another agricultural operation, small changes in biosecurity can make a big impact. Don't miss this essential conversation and update on HPAI.



#### Meet the Presenter: Matt Hille

*Assistant Professor | Nebraska Veterinary Diagnostic Center*

Originally from West Central Nebraska, Matt Hille graduated with a Doctor of Veterinary Medicine degree from Iowa State University. He practiced beef cattle feedlot and cow/calf medicine in South Dakota for approximately five years before coming to the University of Nebraska-Lincoln for a PhD and residency in anatomic pathology, which he completed in 2021. Currently, Hille is an assistant professor and diagnostic pathologist at the Nebraska Veterinary Diagnostic Center. His research and diagnostic interests focus on infectious diseases and immunology of beef cattle.

- Register online in advance
- Expedite your badge
- Download CVENT Events mobile app
- Mark your calendars for upcoming events

**DON'T  
FORGET!**

**CENTRALPLAINSDAIRY.COM**

# BREAKOUT SESSIONS

## The Evolving Dairy Landscape: Addressing Cow Health, Environmental Impacts and Economic Pressures

SPONSORED BY: 

### Session Description:

This session will address hot topics currently impacting the dairy industry. Topics include environmental impacts, animal welfare, food safety and economic issues. Learn how these topics can affect you and your operation.



### Meet the Presenter: Luke Miller

*Dairy Technical Support Specialist | Alltech*

Luke Miller received his bachelor's degree in animal science and doctorate in veterinary medicine from Michigan State University. Upon graduation, he spent eight years practicing as a large animal veterinarian, eventually becoming the practice owner. He practiced all facets of large animal medicine but also aided dairymen in the design and implementation of protocols and standard operating procedures. Then, Miller took a full-time position as the general manager for a 6,000-head, multi-site dairy in Central California. In joining the Alltech team, Miller brings valuable experience and expertise from every level of a dairy operation.

SAVE  
THE  
DATE



2026 EXPO

MARCH 17-19

DENNY SANFORD  
PREMIER CENTER  
SIoux FALLS  
SOUTH DAKOTA

# We Celebrate you.



**Thank you dairy producers  
for choosing us to be your #1!**

# **DAIRY STAR**

*“All dairy, all the time”™*

522 Sinclair Lewis Avenue • Sauk Centre, MN 56378

P: 320-352-6303 | F: 320-352-5647 | [www.dairystar.com](http://www.dairystar.com)

# BREAKOUT SESSIONS

## Learnings and Implementation of On-farm Sustainability Reporting

SPONSORED BY:  **Edge**  
Dairy Farmer Cooperative

### Session Description:

Edge Dairy Farmer Cooperative and Farmers for Sustainable Food announced the impressive outcomes generated in the first year of their U.S. Department of Agriculture Partnerships for Climate-Smart Commodities Program. This panel discussion will bring together representatives of the teams engaged in the program to discuss the outcomes and why farmers are encouraged about the results.



**Moderated by:**  
*Lucas Sjostrom*  
*Managing Director,*  
*Edge Dairy Farmer Cooperative*



**Panelist:**  
*Michael Crinion*  
*Managing Partner,*  
*Ash Grove Dairy*



**Panelist:**  
*Drew Kessler*  
*Scientist and Principal,*  
*Houston Engineering, Inc.*



**Panelist:**  
*Jamie Fisher*  
*Senior Project Manager,*  
*Farmers for Sustainable Food*

# BREAKOUT SESSIONS

## It Starts with the Bugs: Optimizing Rumen Development in Dairy Calves

SPONSORED BY:

**Axiōta**®

### Session Description:

Dairy calves are tasked with a tall order when they are born - to expedite rumen development to allow early transition from liquid to solid feed. When successful, this allows a dairy calf to continue to flourish through the weaning and growing phases. Learn how strategic utilization of a rumen native microbe can enhance rumen development in calf raising.



### Meet the Presenter: Craig Louder

*Technical Services Veterinarian | Axiota Animal Health*

Craig Louder graduated from Washington State University College of Veterinary Medicine in 2012. He joined High Desert Veterinary Services in Jerome, Idaho, where he practiced for nine years, becoming a partner in 2017. In 2018, he began consulting part time for MULTIMIN USA and transitioned to a full-time role as a technical services veterinarian with Axiota Animal Health in September 2021.

**THANK YOU**  
*Dairy Farmers!*



**IS IT TIME TO EXPAND  
AND/OR UPGRADE YOUR  
OPERATION?**

- Manure Management Plans (MMP)
- Federal, State & County Permitting
- Environmental Assessment Worksheets (EAW)
- NRCS TSP Services
- Construction Engineering Services
- Crop Consulting
- Construction SWPPP
- Design & Inspection
- Wetland Services
- Concept Planning & Site Suitability

1700 Technology Drive NE Suite 130, Willmar, MN 56201  
www.anezinc.com 320.235.1970

**DCRC**

Dairy Cattle Reproduction Council

**2025**

**ANNUAL MEETING**

November 11-13  
Middleton, Wisconsin



f in drcouncil.org  

# BREAKOUT SESSIONS

## Optimizing Herd Productivity and Health:

### Advanced Transition Cow Management and Nutrition Strategies

#### Session Description:

The transition period is the most critical and complex phase in a dairy cow's life. Nutritional demands and hormonal changes during this time, both pre- and post-calving, significantly affect immune function, early lactation productivity and future reproductive success. This period greatly influences overall lactation performance, productivity, disease risk and culling rates.

SPONSORED BY:



#### Meet the Presenter: Ruby Wu

*Technical Services Manager | Arm & Hammer Animal Nutrition*

Ruby Wu has been a pivotal member of Arm and Hammer's Field Technical Services team since 2017. In her role, she provides expert technical support to the sales team, key influencers and producers across the Americas. Wu holds a bachelor's degree in animal science from China Agricultural University in Beijing, China. She furthered her education at the University of Georgia, earning a master's degree and PhD in dairy nutrition, with a focus on rumen bypass lysine and dietary cation anion difference (DCAD) feeding for transition cows. Her specialized expertise lies in transition cow nutrition and management. With more than a decade of experience in technical and project management roles, Wu has successfully launched various new products.



## DOWNLOAD THE MOBILE APP "Cvent Events"

- 1 Search Cvent Events in your app store
- 2 Download app
- 3 Search Central Plains Dairy Expo
- 4 **Stay up to date on the latest Expo news, activities, sessions, events & more!**



## ANIMAL NUTRITION IS OUR STRENGTH.

Backed by a legacy brand with over 175 years of research and expertise, our portfolio delivers animal nutrition and gut health solutions for your operation that are tailored to feed their potential and yours.

Visit the **Arm & Hammer Animal Nutrition Booth** at **H102** to learn more.



## ARM & HAMMER ANIMAL NUTRITION

YOUR NUTRITION POWERHOUSE

## You want the best for your herd, and so do we.

“Six years ago we installed 6 stalls of Promat Comfort Mat Mattresses. We noticed quickly that cows would wait to fill the Comfort Mat stalls first. Then we knew we had to do the whole barn. We experienced a 1/2 gallon increase within a month, along with hock improvements. The cows are laying down consistently.”

Jason & Rebecca Streutker

We're here to help you find the right comfort solution for your herd.

🌐 [www.promatinc.com](http://www.promatinc.com)

☎ 226-242-0286

✉ [sales@promatinc.com](mailto:sales@promatinc.com)

🔗 PromatInc

**promat**

# BREAKOUT SESSIONS

## Growing Again: A Look at the Dairy Markets in 2025

### Session Description:

With dry wit and vibrant charts, Sarina Sharp will explain the fundamentals behind the dairy, livestock and feed markets. She'll give an outlook for dairy and beef revenues and feed costs in the year to come so that dairy producers will be empowered to manage their financial risks. Additionally, she will help dairy producers understand the factors that will impact their milk and beef revenues and feed expenses in the year to come, including consumer trends, international milk production and ongoing headwinds to expansion in the U.S. dairy sector.

SPONSORED BY:



### Meet the Presenter: Sarina Sharp

*Commodity Market Analyst | The Daily Dairy Report*

Sarina Sharp grew up on dairy farms in California and then Michigan. For 15 years, Sharp has helped dairy producers and farmers manage their commodity market risk.

## Dry Off: A New Beginning or End of the Line?

### Session Description:

This presentation is to inform producers of the importance of a successful dry-off. Understanding the phases the udder goes through during this process is crucial. Also, it is important to know why dry-off protocols are suggested, as well as the pros and cons of our actions.

SPONSORED BY:



### Meet the Presenter: Chris Rock

*Technical Services Consultant | AHV USA*

Chris Rock is a 2017 graduate of the Iowa State College of Veterinary Medicine. He grew up on a feedlot in northern Iowa and played baseball in college in Dubuque, Iowa, before moving to Ames, Iowa, for veterinary school. He was part-owner of a four-doctor practice until he underwent carpal tunnel surgery on both wrists. Faced with the likelihood of reagravating his injury, he made a career change to begin working for Animal Health Vision, a Netherlands-based animal health company.



# BUILT BY DAIRY PEOPLE...



cloud-based feed management software

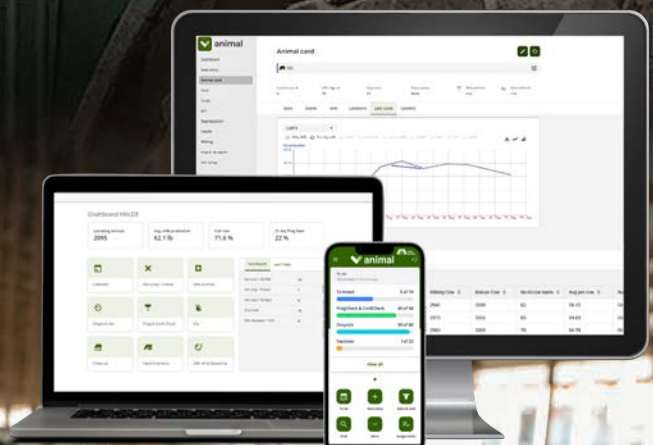
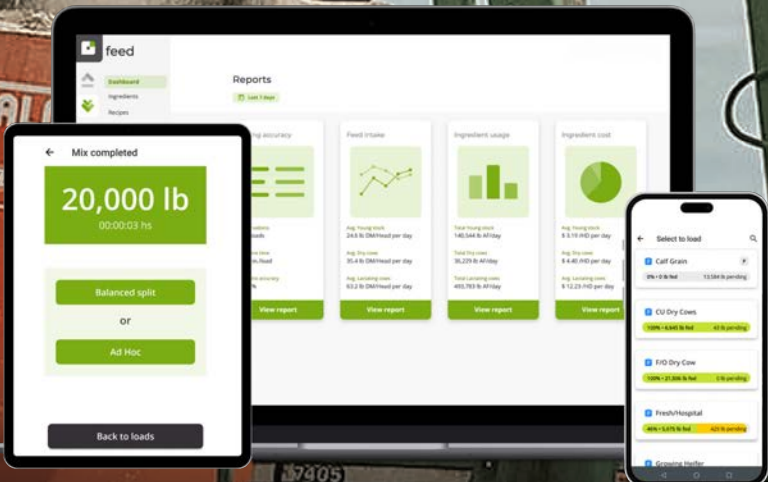

cloud-based herd management software

# ... FOR DAIRY PEOPLE



## LEARN MORE

[milcgroup.com](http://milcgroup.com)



**milc group**

# BREAKOUT SESSIONS

## Practical Insights for Managing Transition Cow Inflammation

SPONSORED BY: **FormAFeed**

### Session Description:

This presentation will provide practical strategies for managing and reducing inflammation in transition cows - focusing on effective management practices that improve herd health and productivity. The presenter will explain the basics of inflammation and the various causes of inflammation in dairy cows. He will define the harmful effects of excessive and unresolved inflammation. Additionally, he will summarize and highlight management practices to help minimize the negative effects of inflammation in transition cows, and offer nutrition strategies to control the extent of inflammation.



### Meet the Presenter: Tim Doherty

*Business Manager | Form-A-Feed*

Tim Doherty is a 19-year veteran of the dairy nutrition and feed business - serving nutrition needs of dairy customers in New England and the Upper Midwest. As a business manager for Form-A-Feed, he provides on-farm nutrition services in Wisconsin and Minnesota, sales team leadership and technical support. He is passionate about dairy cow nutrition, in particular transition cow nutrition and management, as well as the many factors affecting gut health.

## WINE & CHEESE SOCIAL

ON THE TRADE SHOW FLOORS  
WEDNESDAY, MARCH 26 | 4:30 PM

Thank you to our sponsors:



# Grain processing solutions for the forage industry worldwide

- Designed for higher outputs
- Handle all crop lengths
- Hinge open frames
- Easy servicing



Rolls available for all brands of forage harvesters

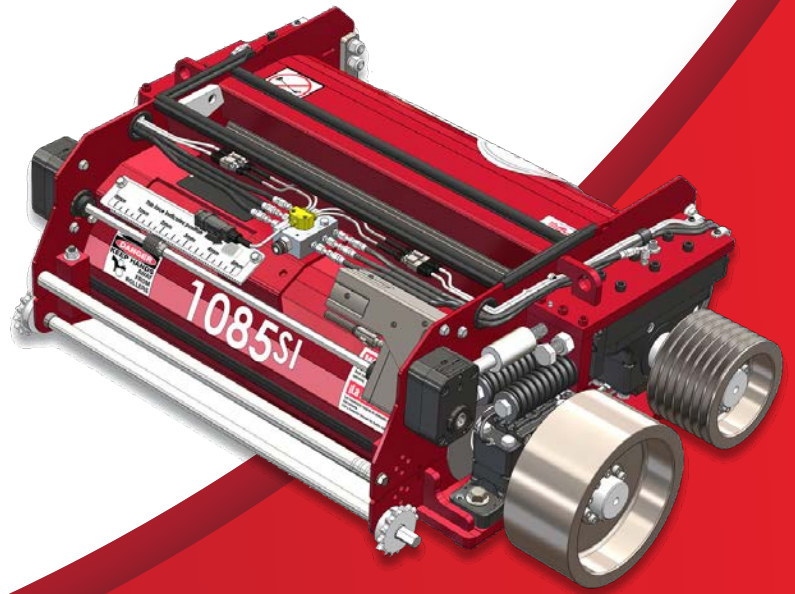

1-800-833-9790 | [schererinc.com](http://schererinc.com)

## ATTENTION DAIRYMEN!



Real-Tuff, Inc. Hoof Trimming Chute is designed to be multifunctional.

- Trim Hooves
- Wrap Hooves
- DA, AI, PG check C-Section
- Other Medical needs
- Extra heavy duty construction
- Can be purchased with a cart
- Comes w/automatic reset headgate

Real-Tuff, Inc. 1/4 Circular Maternity Pen

- Front gate with Ratchet stop
- Split front gate
- 4" Ribbed checker plate floor
- 6' rear access door
- Heavy duty Auto Head gate
- Heavy duty tubing frame and gates
- 6'10" sides
- Easy access by multiple doors to assist the cow and calf
- Automatic lock keeps the door from coming back at the operator
- Designed with your safety in mind
- Dimensions: W-11' H-7' L-8'6"
- 1300 lbs.



Visit [www.realtuff.com](http://www.realtuff.com) for equipment demonstration videos.

1-800-474-6016  
[www.realtuff.com](http://www.realtuff.com)



 **Munters**

ATLAS 74 & CX74

WITH

Munters Drive G2 MAX

[www.munters.com](http://www.munters.com)



# COLOSTRUM TOOLS EVERYONE LOVES



**15<sup>TH</sup>**  
**ANNIVERSARY**



- ✓ Volume pricing
- ✓ No contracts
- ✓ Time-saving
- ✓ Affordable
- ✓ American-made

Golden Calf Company colostrum management systems & tools combine innovation & durability to give your dairy the best product possible. Become a Calf Hero™ at your dairy!

**LEARN  
MORE**

**VISIT BOOTH C-430**  
**OR CALFHERO.COM**

# BREAKOUT SESSIONS

## The Future of Calf Care

SPONSORED BY:



### Session Description:

Our world is developing rapidly and the rate of change is accelerating. We can feel this all around us, but what does it mean for our calves, our farms and our future? What tools do we have to address these shifts and what innovations are on the horizon?

Join us for a forward-thinking presentation that explores the dynamic factors shaping dairy farming today. From emerging trends in food technology to groundbreaking advancements in sustainability, automation and precision agriculture, we'll dive into the forces transforming our industry. Hear firsthand the experience of a business that has spent 15 years driving innovation in the colostrum management and maternity areas. Learn what the presenters have discovered through 15 years of designing cutting-edge tools and working side by side with dairy farmers to solve challenges in early calf care.



### Meet the Presenters: Andrew Beckel & Dagmar Beckel Machyckova

#### *Andrew Beckel - Founder | Golden Calf Company*

Andrew Beckel has transformed how dairy farmers across the United States manage colostrum and care for newborn calves. In 2010, he founded Golden Calf Company in Bloomer, Wis., becoming a passionate advocate for neonatal calf care. He firmly believes in U.S. manufacturing - producing everything from colostrum pasteurizers to bags and tube feeders. Known for his hands-on approach, Beckel goes the extra mile to help farmers enhance their management protocols.

#### *Dagmar Beckel Machyckova - General Manager | Golden Calf Company*

Dagmar Beckel Machyckova is the general manager of Golden Calf Company, a U.S. manufacturer of innovative dairy colostrum solutions based in Bloomer, Wis. Beckel Machyckova is a passionate promoter of technology for dairy farm maternity areas. Her innovative spirit has led to groundbreaking products like the Auto Fill Colostrum Station, which is the first in the industry to provide an objective source for colostrum quality and connecting the dam to calf. Beckel Machyckova's professional interests lie in data-driven innovation, lean manufacturing and organizational systems.

# BREAKOUT SESSIONS

## Prevention and Treatment of Subclinical Hypocalcemia to Optimize Health and Reproduction in Dairy Cattle

SPONSORED BY:



### Session Description:

The presenter will discuss new research that shows the impact of subclinical hypocalcemia on health, rumination, reproduction and production. In addition, she will report on strategies to prevent and treat hypocalcemia, including dietary strategies and the use of calcium boluses. Attendees will learn about the impact of subclinical hypocalcemia, strategies that may prevent hypocalcemia and potential tactics for treating hypocalcemia.



### Meet the Presenter: Clair Seely

*Assistant Professor | University of New Hampshire*

Clair Seely is an assistant professor at the University of New Hampshire. Her research focuses on the integration of dairy cow biology and precision dairy technologies. With a specific emphasis on epidemiological methods, through her research she hopes to expand our knowledge of transition cow physiology while optimizing and validating technologies that can improve cow health, well-being and productivity.

**0.83**  
Airflow  
Ratio

**MEGA  
DIRECT  
DRIVE**  
72" Exhaust Fan

See it  
at CPDE!

**58,368**  
CFM  
@ 0.10" SP

JDMFG.COM  
**J&D**  
Manufacturing

**Performance  
& Reliability**  
you can count on.

Best-in-class rotary parlor installation and maintenance!

Your robotic milking system dealership of choice!

**FARM  
SYSTEMS**

farm-systems.com

© 2023 Farm Systems. All rights reserved. A-5471510554



# YEA-SACC<sup>®</sup> 1026 BAC

A cost-effective solution to improve rumen efficiency and enhance gut health



### Benefits of Yea-Sacc 1026 BAC

Increases milk production ~2.2 lbs/day



Stabilizes rumen pH



Improves defense against undesirable organisms

Visit **Alltech** at **Booth C415** at Central Plains Dairy Expo!

# NEBRASKA

## LAND.WATER.OPPORTUNITY.

Groundwater-Level Changes in Nebraska - Spring 1981 to Spring 2021

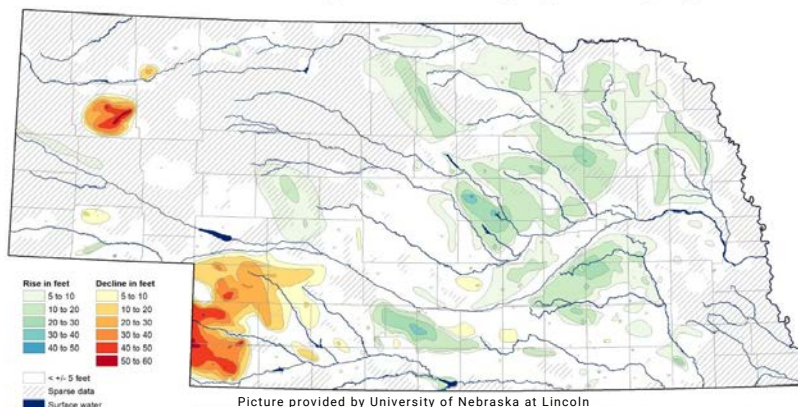

- #1 In irrigated acres
- The High Plains Aquifer under Nebraska has 5X the amount of water as Lake Erie
- Ground Water is managed by local Natural Resource Districts with a long term goal of sustainability

REACH OUT TO NEBRASKA STATE DAIRY ASSOCIATION TO DISCOVER WHY NEBRASKA IS THE PREMIER STATE FOR DAIRY!

VISIT [WWW.NEBRASKAMILK.ORG](http://WWW.NEBRASKAMILK.ORG) OR CALL 402.525.3199



# BREAKOUT SESSIONS

## Youngstock Monitoring: Insights Gained and Future Opportunities

### Session Description:

Wearable health monitoring technology is a new development in the calf space. Both expected and unexpected outcomes have arisen. We will explore real-world scenarios, opportunities and potential future features. By attending this session, attendees will understand the importance of young stock health monitoring and develop skills to interpret monitoring data and use it for decision making.

SPONSORED BY:



### Meet the Presenter: Sarah Anderson

*Customer Success Specialist | Merck Animal Health*

Sarah Anderson is the Midwest dairy monitoring success specialist for Merck Animal Health. Anderson was first introduced to the SenseHub technology when she worked at her home farm of 1,000 cows in Lancaster, Wis., from 2010-2016. She then supported the monitoring technology at Semex, where the technology is known as AI24. She joined Merck in March 2020 where she works directly with customers post-sale to help them ensure success with their monitoring system from adjusting protocols, training staff and maximizing return on investment.

## EDUCATION SHED (ED SHED)

*An opportunity to educate attendees and promote your products and services. Check out page 70 for details.*

Video cameras to protect your property, your equipment and your livestock.



### FEATURING:

- Calving Barns
- Bio-Security
- Night Vision
- Watch for Animal Welfare
- Intrusion Detection
- Dairy Parlor
- Fuel
- Commodities

Watch on your smartphone, tablet or computer

Wireless Transfer from Barn or Shop to House



Call 952-405-0098  
or  
Email [info@agtechbusiness.com](mailto:info@agtechbusiness.com)



CholiGEM™ is the very

# CORE

of transition cow health.



An advanced rumen-protected choline chloride supplement from Kemin, designed to address fatty liver and ketosis.

Explore what this innovative rumen-protected choline solution can do for your herd.



CholiGEM™

[kemin.com/choligem-us](http://kemin.com/choligem-us)



© Kemin Industries, Inc. and its group of companies 2024. All rights reserved. ®™ Trademarks of Kemin Industries, Inc., U.S.A.



# THE LADIES LOVE

**LEGEND  
RUBBER®**

PHONE - (248) 301-2349  
INFO@LEGENDRUBBER.CA

[LEGENDRUBBER.CA](http://LEGENDRUBBER.CA)

THE BEDROCK OF HEALTHY HERDS  
SINCE 2004



**UDDER TECH**

**Waterproof Workwear**  
Machine wash & dry



Visit our booth or  
shop online!

888.438.8683

[uddertechinc.com](http://uddertechinc.com)

# BREAKOUT SESSIONS

## Maximizing the Profit Centers Within Your Feed Management System

SPONSORED BY:



### Session Description:

In this interactive session, the presenter will reveal how to understand and maximize the profit centers within a feed management system. Your program should help define the culture of your dairy and evaluate change. Use the data at hand to work through the mindset of more milk vs. components and what is best for your business. Learn the basic steps that are crucial to solid data and sound decisions.



### Meet the Presenter: Keith Sather

*President | Supervisor Systems/KS Dairy Consulting*

Keith Sather is the owner and creator of KS Dairy Consulting and Supervisor Systems. Sather is a 1984 graduate of the University of Wisconsin-River Falls, where he majored in animal science. Following nine years in the feed industry, he founded KS Dairy Consulting, with a focus on dairy nutrition and responsible management practices. Shortly after he formed Supervisor Systems, he created Feed Supervisor, Hoof Supervisor and Truck Supervisor. Sather works with dairy producers, consultants and hoof trimmers throughout the world, with a commitment to excellence and innovation.

- Register online in advance
- Expedite your badge
- Download CVENT Events mobile app
- Mark your calendars for upcoming events

**DON'T FORGET!**

**CENTRALPLAINSDAIRY.COM**



**SOUTH DAKOTA STATE UNIVERSITY**

College of Agriculture, Food and Environmental Sciences

## 20+ Majors and Specializations

State-of-the-art facilities for hands-on learning supporting the next generation of dairy producers and food processing specialists

Meet our  
**SDSU DAIRY TEAM**  
at our booth during CPDE



**20**  
MINORS  
**6**  
CERTIFICATE PROGRAMS



### Connect with us:

call: (605) 688-5133 email: [sdsu.academic.programs@sdstate.edu](mailto:sdsu.academic.programs@sdstate.edu)

@SDStateCAFES SDState Agriculture, Food and Environmental Sciences @sdstatecafes

SDState - College of Agriculture, Food and Environmental Sciences [sdstate.edu/cafes](http://sdstate.edu/cafes)

Visit us at Central Plains Dairy Expo Booth C602.

# Tobex®

## Premise Fly Control Made Easy

Reduce flies and strengthen neighborhood ties with Tobex® Multi MoA Concentrate. This highly effective insecticide is a powerful combination of a synergist, IGR, knockdown agent and long-lasting insecticide all-in-one with controlled-release technology. Don't waste your precious time mixing products - get multiple modes of action in one bottle with Tobex.

### Features & Benefits:

- > Ideal for premise treatments at dairy facilities
- > Kills and controls flies and darkling beetles (see label)
- > Formulated with NyGuard® IGR
- > Convenient all-in-one product, no tank-mixing required



[MGK.com/Tobex](http://MGK.com/Tobex)





# TODAY IS YOUR OPPORTUNITY **TO** BUILD THE TOMORROW YOU WANT.

At Trans Ova Genetics, we're empowering breeders to build a tomorrow that exceeds expectations. We provide the complete toolbox of services you need to create a legacy of excellence. Today's choices shape tomorrow's success. Choose Trans Ova Genetics and leave a lasting legacy for the next generation.

For a full list of locations, visit [www.transova.com](http://www.transova.com)

**TRANS**  **OVA**  
genetics

EMBRYO TRANSFER • IN VITRO FERTILIZATION • SEXED SEMEN  
DONOR HOUSING • RECIPIENT OPTIONS • GENETIC PRESERVATION • CLONING

# BREAKOUT SESSIONS

## The Power of the Female

### Session Description:

In an effort to share the power of in vitro fertilization, we will focus on the true importance of focusing on the female. We will look at what she offers to the genetic growth and profitability of a producer's bottom line. We will look further into the implications improvements in genetics have and how to utilize embryos in a genetic program. Learn how the female plays an influential role in accelerating genetic growth. Understand strategies to integrate embryo use to maximize profitability and how embryos differ from conventional artificial insemination in terms of genetic growth.

SPONSORED BY:



## Meet the Presenter: Chelsea Abbott

*Dairy Consultant | Trans Ova Genetics*

Chelsea Abbott grew up in Vermont showing Holsteins. She studied dairy science at Virginia Tech and received a master's degree in dairy reproductive physiology from the University of Tennessee. Abbott worked as a consultant for a few years, before moving to Montana. She returned to the dairy industry as a dairy consultant for Trans Ova Genetics.



### SERVICES WE PROVIDE:

- INCOME TAX PLANNING & PREPARATION
- QUICKBOOKS CONSULTING
- BREAKEVEN/CASH FLOW ANALYSIS
- ACCRUAL ACCOUNTING/BENCHMARKING
- PART-TIME CFO



### There's More...

More than just good enough.

113 3rd Street NE | Orange City, IA 51041  
712.737.2030 Office | 712.737.2075 fax  
www.vbandv.com

## Built to dairy better.



@NDEcoTMR

www.NDEco.com | 888.336.3127

# BREAKOUT SESSIONS

## From Data to Impact: Maximizing Dry Matter Intake for Optimal Performance

SPONSORED BY:



### Session Description:

In this session, Van Beek will dive into the feed reasoning behind dry matter intake (DMI), focusing on its direct influence on animal health, productivity and overall farm performance. He will explore why DMI matters beyond the numbers and how having the right data supports better decision making. By taking a hands-on approach to bridge the gap between scientific insights and business strategies, you will leave the session empowered to enhance performance and profitability through smart feeding practices. Join us as we show you how maximizing DMI can drive measurable, lasting improvements in your dairy operation.



### Meet the Presenter: Ron Van Beek

*Founder | Van Beek Natural Science*

Ron Van Beek is a visionary entrepreneur with more than 40 years of dedicated experience in advancing animal health and performance. As the founder of Van Beek Natural Science, Van Beek has built a company that stands as a trusted leader in the animal health industry, renowned for its innovative, nature-based solutions. Driven by a passion for sustainable agriculture, Van Beek has empowered livestock producers to achieve greater profitability and long-term growth by offering science-backed, results-oriented product portfolios.

## FREE COFFEE

WEDNESDAY & THURSDAY AM  
SERVED ON THE SHOW FLOOR

Thank you to our sponsors:



# BREAKOUT SESSIONS

## Do High Oleic Soybeans Fit Your Farm?

### Research and Producer Panel Discussion

SPONSORED BY:



### Session Description:

High oleic soybeans are a novel tool in the nutrition toolbox for farmers exploring energy-dense diets with reduced risk for rumen disruptions and milk fat depression. Join Vita Plus for a conversation highlighting the research and practical application of this technology on productive dairy herds. Through a dynamic panel discussion, Harvatine will explain the science behind high oleic soybeans, accompanied by the practical advice of two dairy producers - Nathan Brandt and Tim Hood. They have multiple years' experience growing, roasting and feeding high oleic soybeans.



*Presenter*

*Kevin Harvatine,  
Professor of Nutritional Physiology,  
Penn State University*



*Panelists*

*Nathan Brandt,  
Four Cubs Farm,  
Grantsburg, Wis.*



*Tim Hood,  
Hood Farms LLC,  
PawPaw, Mich.*

## Meet the Presenter: Kevin Harvatine

Kevin J. Harvatine is professor of nutritional physiology at Penn State University. He grew up on his family's dairy farm in Pennsylvania and received his bachelor's degree in animal science from Penn State. He earned a master's degree from Michigan State University and PhD from Cornell University. Harvatine's research is focused on factors that impact milk fat synthesis strategies to improve milk fat yield. His research spans from applied nutrition to basic biology and provides real-world applications to the dairy industry and a basic understanding of biological mechanisms. Current ongoing projects focus on optimal methods for balancing dietary fat, including how to best utilize high oleic soybeans.

# BREAKOUT SESSIONS

## U.S. Genetic Progress – Where Did We Gain and Where Did We Fall Short?

SPONSORED BY: 

### Session Description:

Every five years, we reset the dairy cattle genetic base in the United States. 2025 is a genetic base change year. This provides a chance to review and reflect on our dairy cattle's genetic progress. How did we do? How does it compare to past base changes? We can use this as a road map for the future and see where we can place more emphasis to help breed for the most profitable cow.

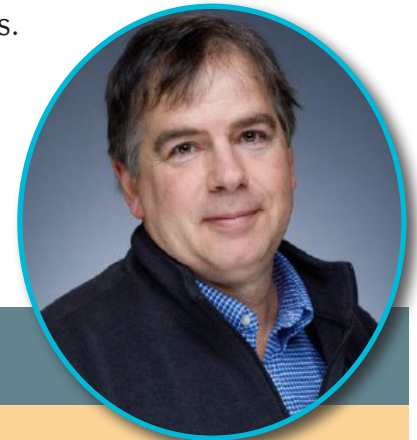

### Meet the Presenter: David Erf

*Senior Dairy Technical Services Geneticist | Zoetis*

Born and raised on a dairy in North Central Ohio, David Erf is a member of the Zoetis Dairy Technical Services team as a dairy geneticist. In this role, he assists with the CLARIFIDE dairy genomic testing program. He helps customers realize the full potential of genomic testing by understanding and utilizing genomic data. He received a bachelor's degree in dairy science from Ohio State University and a master's degree in animal breeding from the University of Minnesota. Erf has more than 20 years of experience in the artificial insemination industry and has served on numerous boards and committees dealing with dairy cattle genetics.

## FREE GRILLED CHEESE SANDWICHES



AT THE VALLEY QUEEN  
CHEESE DAIRY BAR

Thank you to our sponsors:





# BREAKOUT SESSIONS

## Setting Up Calves for Success Before Birth Through Dam Nutrition

### Session Description:

Many nutritional strategies are implemented in the close-up period to enhance postpartum cow health and performance. These nutritional strategies may also be altering the performance of her offspring and can have long-lasting implications. This presentation will review the dam nutritional strategies that affect calf performance and how that may impact a farm's bottom line.

SPONSORED BY:



**balchem**



### Meet the Presenter: Billy Brown

*Assistant Professor | Kansas State University*

Billy Brown grew up on his family's beef and hay operations during their time in Louisiana, Texas and Kansas. He studied animal science with a dairy emphasis at Kansas State University (KSU), before completing a master's degree in dairy cattle nutrition at Michigan State University. He took a five-year break from academia to promote Kansas agriculture while working at the Kansas Department of Agriculture. Next, Brown completed a doctoral program in dairy cattle nutrition at KSU, followed by postdoctoral training at the University of Wisconsin-Madison. Joining the KSU faculty in 2022, where he is responsible for teaching introductory dairy and general nutrition courses, his research program focuses on dairy cattle nutritional physiology, with a particular interest in elucidating mechanisms contributing to variation in nutrient utilization and feed intake regulation in lactating dairy cows and development programming in calves.



## FREE PANCAKE BREAKFAST

THURSDAY, MARCH 27 - 8:00AM  
LOCATED IN THE ARENA

Thank you to our sponsor:



# BREAKOUT SESSIONS

## Commodity Price Risk Management – Protect Your Bottom Line

SPONSORED BY:  **CIH**

### Session Description:

Dairy margins and profitability will continue to be volatile in the years to come. The presenter will highlight some of the more important data and reports to follow, risk management tools at your disposal and different methodologies and strategies to consider to actively manage your dairy's commodity price risks and profit margins.



### Meet the Presenter: Mark Newman

*Account Executive | CIH*

Mark Newman has been an account executive on CIH's dairy desk since 2019. He helps dairy producers across the country manage their risk, identify opportunities and develop comprehensive margin management strategies in this volatile economic climate. Newman attended the University of Iowa where he graduated with a bachelor's degree in economics and a master's degree in finance. He also holds a series 3 license (National Commodities Futures Examination).

## BEER GARDEN

LOCATED ON THE NORTH  
END BETWEEN CONVENTION  
CENTER AND ARENA

Thank you to our sponsor:





# BREAKOUT SESSIONS

## Elevate Your Dairy Operation with New Innovations from VAS

SPONSORED BY:



### Session Description:

Join us as we share the latest innovations from VAS. We'll dig into VAS' new embryo management module, expanded data entry capabilities, improved switch management and cow care features. Leverage these tools on your dairy to optimize herd health, boost milk production and simplify your team's daily workflows. Unlock new levels of efficiency and profitability with VAS' herd management solutions.



## Meet the Presenters: Dylan Ash & Meagan Young

### *Dylan Ash - Farm Performance Consultant | VAS*

Leveraging his passion for the dairy industry, Dylan Ash collaborates with dairy producers and industry professionals in Minnesota as a farm performance consultant for VAS. He graduated from Dordt University where he earned a bachelor's degree in business administration, broadening his network and expertise within the dairy industry. In his current role, Ash aims to enhance operational efficiency for producers and empower them to make more informed, data-driven decisions - utilizing VAS' suite of products.

### *Meagan Young - Voice of Customer Program Manager | VAS*

Meagan Young is the Voice of Customer Program Manager at VAS building an ecosystem of customer insights that drives customer experience. She has been with VAS for 5 years beginning as a Software Support Specialist and managed the Dairy Support Team of 24 highly talented individuals for 3 years before moving into the Voice of Customer Role. Meagan is an alum from Colorado State University where she studied Agricultural Business and Spanish.

# BREAKOUT SESSIONS

## Dairy Checkoff and State Trade Association Networking Reception

SPONSORED BY:



### Session Description:

At Midwest Dairy, we proudly represent 4,000 dairy farm families to 41 million consumers across our 10-state region. We work on their behalf to build dairy demand by inspiring consumer confidence in dairy products and production practices. We focus our efforts on sharing insights and developing programs for our retail, food service, health and wellness, school STEM and industry partners. Midwest Dairy's goal is to maximize our impact by working with and through partners to share resources, insights and real-time experiences that showcase how dairy products resonate with today's consumer.

Stop by our booth #C204 on Wednesday, March 26, beginning at 2 p.m., for a checkoff taste and learn experience to sample new product innovations that have resulted from your checkoff investment.

Midwest Dairy, your local checkoff organization, in partnership with South Dakota Dairy Producers Association, Nebraska State Dairy Association, Iowa State Dairy Association and Minnesota Milk Producers Association invite you to join us for a networking reception on Wednesday evening, March 26, to engage with your local checkoff staff, as well as state trade representatives.

### DGN connect LUNCHEON

Attend the Dairy Girl Network luncheon at Central Plains Dairy Expo from 11:30 a.m. to 1:00 p.m. on Wednesday, March 26, 2025, in Sheraton Ballroom A.

This lunch is for all women involved with any part of dairy - whether as a calf feeder, dairy owner, marketing or sales consultant servicing dairy farms or cheese producers, veterinarians, researchers, etc. If you are a dairy supporter or there is a dairy cow involved in what you do, you're invited.

There will be a cost for this luncheon. Visit [DairyGirlNetwork.com](http://DairyGirlNetwork.com) to learn more and register for this inspiring networking opportunity.

Join Dairy Girl Network here at Central Plains Dairy Expo!



[DairyGirlNetwork.com](http://DairyGirlNetwork.com)

# Reduce Fecal Shedding with Vaxxon® SRP® Salmonella Vaccine



## Reduce fecal shedding to help control **Salmonella**.

Vaxxon® SRP® Salmonella Vaccine is proven to reduce the shedding of Salmonella bacteria in the feces of cattle by 75%<sup>1</sup>.

This graph shows the percentage of cattle that were culture positive for Salmonella in their feces during the 14 days after *Salmonella Newport* challenge.

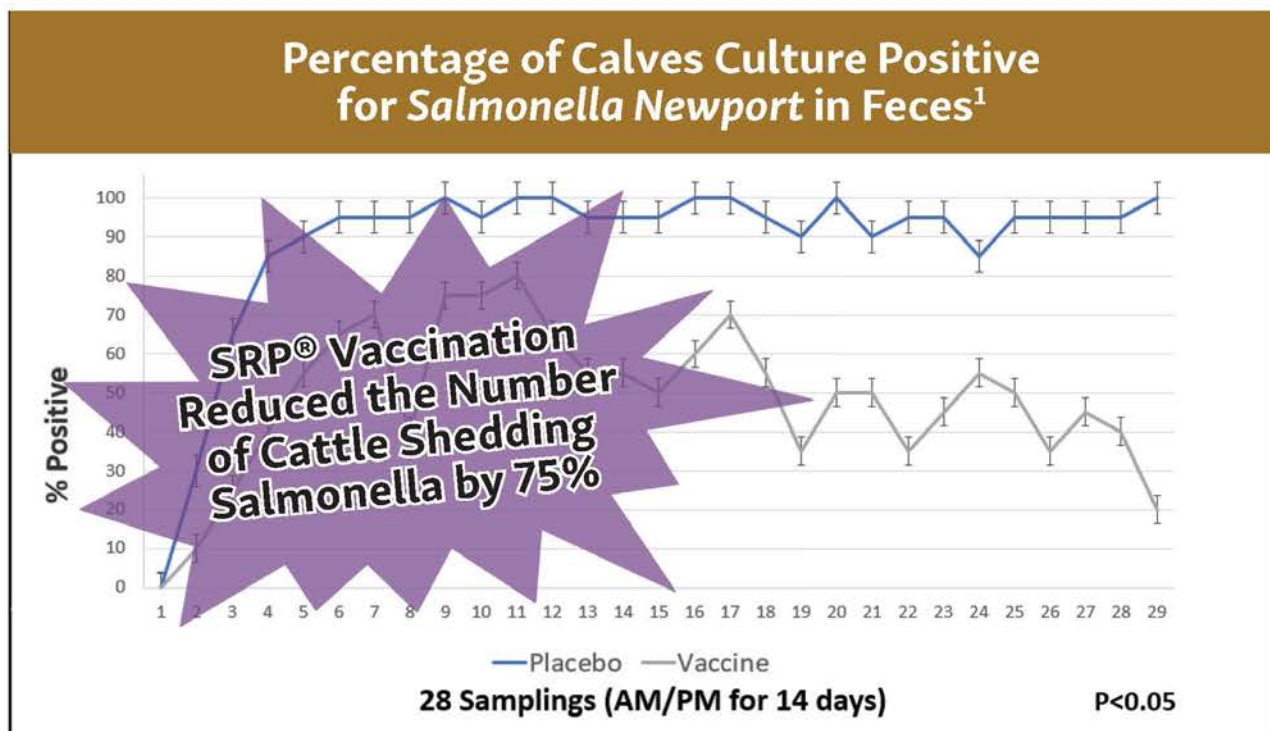
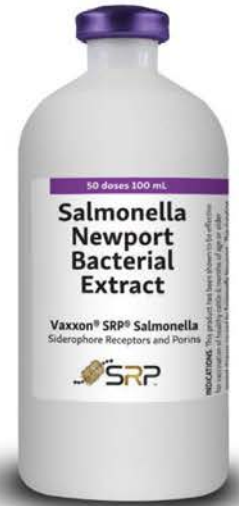

## WHY IS **SALMONELLA** PREVENTION IMPORTANT?

The most common symptoms of Salmonellosis in dairy cattle are diarrhea, fever, abortion, and death. Salmonella infections may also be subclinical where they decrease milk production and feed efficiency and increase cull rates. Salmonella can be transmitted to humans. An estimated 1.35 million illnesses and 420 deaths occur each year in the United States due to Salmonella infections.<sup>2</sup>

References: <sup>1</sup>Vaxxinoa Study 0606 <sup>2</sup>CDC. Antibiotic Resistance Threats in the United States, 2019

# COUNT ON THE BUTLER TEAM FOR YOUR AG EQUIPMENT NEEDS

We carry a large variety of ag equipment to maximize your operation's productivity.



Butler



Butler  
AG EQUIPMENT

Visit us at  
[ButlerMachinery.com](http://ButlerMachinery.com)

# Valley Queen

WE MAKE DAIRY

Proud Supporter of  
Central Plains Dairy Expo

Valley Queen has been dedicated to the success of its customers, employees, and dairy producers since it first opened in Milbank, SD in 1929. Our core values of ethics and excellence drive us to improve the livelihood of our staff and the vitality of the communities we serve.



LEARN MORE:



[VALLEYQUEEN.COM](http://VALLEYQUEEN.COM)



605-432-4563

# BREAKOUT SESSIONS

## To 7 Pounds and Beyond – Maximizing Milk Components for Profitability

SPONSORED BY:



### Session Description:

In most milk markets, dairy farmer milk checks are determined by the pounds of milk fat and milk protein sold. (Other solids are less valuable.) Dairy farmers can impact milk components through genetics, feeding programs and management. This fast-paced presentation will focus on feeding approaches to maximize milk fat and protein. Sources of each milk component will be examined. The role of dry matter intake, peak milk, transition feeding, amino acids, fatty acids, sugar and feed additives will be discussed. On-farm tools will be discussed to find opportunities to improve yield of components.



### Meet the Presenter: Michael Hutjens

*Professor Emeritus | University of Illinois*

Mike Hutjens was raised on a grade Holstein farm near Green Bay, Wis., and earned bachelor's, master's and PhD degrees from the University of Wisconsin-Madison. From 1971 to 1979, Hutjens was the extension dairy specialist at the University of Minnesota where he coached the national champion collegiate dairy judging team in 1978 at World Dairy Expo. Since 1979, he has been a member of the University of Illinois animal sciences department as extension dairy specialist, until his retirement on Dec. 31, 2010. During his career, he earned several awards, including Undergraduate Teaching Purina Award from the American Dairy Science Association (ADSA), National DeLaval Extension Worker Award, Applied Nutrition Award from ADSA, Outstanding Extramural Instructor (University of Illinois award) and two citations from the Minnesota Board of Regents. Hutjens served as the 2004-2005 ADSA president. In 2008, he was named World Dairy Expo's "Service Person of the Year."



Thank you to all  
our sponsors!

# BREAKOUT SESSIONS

## Ultraplus Sex Sorted Semen: Huge Technology Packed in a Tiny Straw

SPONSORED BY: **STgenetics**<sup>®</sup>

### Session Description:

Sexed-sorted semen has been on the commercial market for nearly 20 years. The technology continues to make improvements and the current Ultraplus generation of sex-sorted semen from STgenetics is the most advanced technology in the industry. In this discussion, we will dive into the technological advancements with sex-sorted semen and the use of Ultraplus sex-sorted semen to help make dairies more profitable through genetic progress. Plus, we'll take a fresh look into the future technology of sex-sorted semen.



### Meet the Presenter: Eric Zwiefelhofer

*Central USA Dairy Sales Manager | STgenetics*

Eric Zwiefelhofer is originally from northwestern Wisconsin where he grew up on his family's dairy farm. He earned a bachelor's degree in dairy science from the University of Wisconsin-River Falls in 2015. He continued his education at the University of Saskatchewan in Canada where he earned his PhD in veterinary biomedical sciences in 2020. His PhD research focused on ovarian synchronization prior to embryo collection and fixed-time artificial insemination in cattle. After his PhD, he completed a postdoc developing protocols for oocyte collection, embryo transfer and fixed-time artificial insemination in bison. He joined the STgenetics team in 2022 where he is a strategic account manager within the Dairy Technical Services team. Currently, he is the Central U.S. sales manager for the Dairy team and works with producers across the United States.

# Get Your Golf On!

## SAVE THE DATE!

July 30, 2025

See page 68 for details!





# BREAKOUT SESSIONS

## High Sand Reclamation: What Types of Sand Work Best?

SPONSORED BY:



### Session Description:

Sand is considered the “gold standard” of dairy cow bedding, but not just any sand is good for recycling and reuse. There are a variety of factors to consider when selecting the grade of sand used for dairy cow bedding. These factors take into account what is needed for cow health and comfort, as well as what allows for the highest amount of reclamation. The method in which a dairy handles their sand-laden manure contributes to the grade of sand needed as well. Join us to learn more about what type of sand will keep your cows healthy and producing milk while allowing you to recycle the highest amount of sand and save your dairy money.



### Meet the Presenter: Renee Schrift

*Business Line Director - Agricultural Systems | McLanahan Corporation*

Since joining the company in January 2001, Renee Schrift has worked to expand McLanahan’s customer base and dealer network, and she continues to serve as a resource for dairy producers. She now leads the Agricultural Systems Business Unit, further developing the global growth of the brand. Schrift attended The Pennsylvania State University, where she attained a bachelor’s degree in dairy and animal science.

## ICE CREAM TREAT

PICK UP YOUR FREE ICE CREAM TREAT IN  
THE VALLEY QUEEN CHEESE DAIRY BAR



Thank you to our sponsor:  
**WELLS ENTERPRISES**

# BREAKOUT SESSIONS

## The Dairyman's Perspective of the Feed Market Outlook and Dairy Margins

SPONSORED BY:  Ever.Ag

### Session Description:

Feed is one of the largest costs on the balance sheet. Thus, it's important for dairymen to manage price risks related to the grain market. Grain markets are usually looked at from the perspective of a grain sell, but dairies need to approach the markets like a grain elevator and utilize the same tools available to manage their price risk with both corn and soybean meal, but also byproducts and corn silage. How can a dairy manage feed prices and what does 2025 look like on the horizon for feed and grain - and with it - milk margins?



### Meet the Presenter: Jenny Wackershauser

*Senior Dairy Analyst and Feed Foundations Advisor | Ever.Ag*

Jenny Wackershauser is a senior dairy analyst and feed foundations advisor at Ever.Ag. After 12 years of feed byproduct trading to dairies and feed mills, Wackershauser joined the Ever.Ag team in 2018, helping clients manage their feed risk and milk risk - utilizing CME futures and options or DRP (Dairy Revenue Protection) and LGM (Livestock Gross Margin) insurance. Growing up on a small, registered Holstein dairy in Southwest Wisconsin, she continued her education at the University of Wisconsin-Platteville. With animal science and agriculture business degrees, Wackershauser brings her hands-on knowledge of the dairy and feed industries to Ever.Ag clients as they navigate volatile markets.

- Register online in advance
- Expedite your badge
- Download CVENT Events mobile app
- Mark your calendars for upcoming events

**DON'T FORGET!**

**CENTRALPLAINSDAIRY.COM**

# BREAKOUT SESSIONS

## Managing Milk Prices in 2025

SPONSORED BY: 

### Session Description:

Milk markets are as volatile as ever with new cheese capacity coming online, exports uncertain and new pricing formulas coming in June 2025. Get an update on the programs available for dairy producers today - Dairy Margin Coverage, Dairy Revenue Protection (DRP) Insurance, Livestock Gross Margin (LGM) - Dairy Insurance, futures, options and more. But, hedging doesn't need to be complicated. This session will keep risk management simple, straightforward and arm you with what you need to know to implement a successful program on your dairy.



### Meet the Presenter: Katie Burgess

*Dairy Market Advising Director | Ever.Ag*

Katie Burgess developed a passion for the dairy industry while growing up on a Wisconsin dairy farm and joined the Ever.Ag team in 2012. She works with clients across the dairy supply chain, including producers, cooperatives, processors, retailers, restaurants and multi-national end-users. As a trained economist and commodity broker, she keeps customers updated on dairy supply and demand fundamentals, and helps them manage price volatility via hedging programs. She holds a master's degree in agricultural and applied economics, and a bachelor's degree in agricultural business management, both from the University of Wisconsin.



**FOLLOW US ON OUR SOCIAL NETWORKS**

USE THE HASHTAG  
**#CPDE2025**



# BREAKOUT SESSIONS

## Unleashing the Power of Alfalfa in Your Cropping System – A Fireside Discussion

SPONSORED BY:  **Forage Genetics**  
International

### Session Description:

Learn about the benefits of high-yielding, high-quality alfalfa during this fireside chat-style discussion hosted by Erika Rodbell, forage research agronomist with Forage Genetics International. In this session, the presenter will discuss solutions to challenges that this unique forage can provide for your dairy operation. Rodbell will also discuss how alfalfa can be managed for higher yield, better quality and flexibility for a better return on investment on your operation.



### Meet the Presenter: Erika Rodbell

*Forage Research Agronomist | Forage Genetics International*

Erika Rodbell is a forage research agronomist at Forage Genetics International. Rodbell is responsible for using applied research experience in sustainable agriculture and pest management to provide education and training around alfalfa pest management to agronomy retailers and producers. She earned her bachelor's degree in conservation biology from St. Lawrence University, her master's degree in entomology and sustainable agriculture from Iowa State University, and her PhD from Montana State University-Bozeman, where she researched pyrethroid resistance in the alfalfa weevil across the Intermountain West.

## FREE COFFEE

WEDNESDAY & THURSDAY AM  
SERVED ON THE SHOW FLOOR

Thank you to our sponsors:

TRANS  genetics



va  inova





 IADG  
IOWA AREA DEVELOPMENT GROUP



# Come Make an Impact with Agropur!

Many **Career Opportunities** in a stable industry

Learn with our outstanding **internships** and **seasonal jobs!**

Join in the **growth** of the **dairy industry** in the I-29 Corridor by joining

.....  
Agropur's facilities in:

**Lake Norden, SD**

**LeSueur, MN**

**Hull, IA**  
and

**Several Other Locations Across North America**



COME VISIT US AT  
**THE CENTRAL PLAINS DAIRY EXPO**

BOOTH C122

March 25-27, 2025



Cheese



Ingredients



Better Dairy. Better World.  
[www.agropur.com/us](http://www.agropur.com/us)

# BREAKOUT SESSIONS

## Advantages of Rotary Milking

SPONSORED BY: 

### Session Description:

From single-operator rotaries to multi-site dairies, the milking center is the heart of a dairy farm. In this session, a panel of dairy producers will share how the installation of rotary parlors has helped them increase efficiency while meeting their labor and production goals. From 40 to 120 bails, attendees will learn how dairies of all sizes have included the building of a rotary to satisfy their production targets and prepare for the future.



### Meet the Presenter: Jeff Hahn

*Solution Manager, Rotaries, Parlors, and Milking Systems | DeLaval*

Jeff Hahn, solution manager, rotaries, parlors, and milking systems at DeLaval, has been in the dairy industry for more than 20 years, holding roles at local Wisconsin dealerships and DeLaval North America throughout that time.

## Top prices paid for YOUR CATTLE

**AMERICAN FOODS GROUP**  
KIMBALL, MN

**TIM SCHIEFELBEIN**  
**320-398-2700**  
Holstein Contracting  
Dairy Cross Fats

**AFG - HUTCHINSON BUYING STATION**  
HUTCHINSON, MN

**RICKY SCHIEFELBEIN**  
**320-304-2346**  
Holstein Steers • Lean Cows • Dairy  
Cross Fats • Fed Cows • Bulls

**CATTLE BUYER**  
LONG PRAIRIE, MN

**RILEY RUBLE**  
**507-402-2520**  
Holstein Steers • Lean Cows • Dairy  
Cross Fats • Fed Cows • Bulls

**LONG PRAIRIE PACKING**  
LONG PRAIRIE, MN

**TYREL LEMBKE**  
**877-300-9298**  
Bulls • Lean Cows

**LONG PRAIRIE BUYING STATION**  
LONG PRAIRIE, MN

**BRANDON VANHAVERMAET**  
**302-290-9220**  
Holstein Steers • Lean Cows • Dairy  
Cross Fats • Fed Cows • Bulls

**CIMPL'S**  
YANKTON, SD

**CHAD MCQUADE**  
**605-668-4275**  
Bulls • Lean Cows • Fed Cows

**GREEN BAY DRESSED BEEF**  
GREEN BAY, WI

**DEAN DERRICKS**  
**920-436-6529**  
Holstein Steers • Lean Cows  
Dairy Cross Fats • Fed Cows

**GIBBON PACKING**  
GIBBON, NE

**MIKE BACZWASKI**  
**800-445-0042**  
Fed Cows • Bulls • Lean Cows

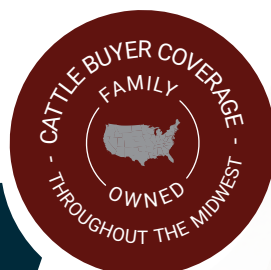

**HOLSTEIN STEERS • BULLS • FED COWS**  
**LEAN COWS • DAIRY CROSS FATS**

 **AMERICAN  
FOODS GROUP**

[AmericanFoodsGroup.com](http://AmericanFoodsGroup.com)



# BREAKOUT SESSIONS

## Optimizing Calf Health: Strategies for Management, Nutrition and Immunity

SPONSORED BY:



### Session Description:

During this presentation, the presenter will talk about optimizing calf health and performance. She will talk about stressors that calves go through and management strategies that can minimize the effects of those. Nutrition is often thought of in terms of growth rate, but the presenter will relate that back to the health of the calf, as well. The presentation will conclude with immunity and how nutrition and management relate to a calf's immune response.



### Meet the Presenter: Minnie Ward

*Business Coach | Everything Calves Consulting LLC*

Minnie Ward and her family own and operate a custom calf-raising facility. Her career started as a preschool teacher. Having grown up on a dairy farm, it became apparent the dairy industry was where she needed to be. Ward discovered that working with calves was her true passion. During her career, she has worked as a herdsman on a few large dairies and nutritionist/calf and heifer specialist for Land O'Lakes/Purina, Sci-Tech and Form A Feed. Most recently, Ward worked for Calf Star as the company's Midwest sales representative. Last April, she started her own calf consulting business - specializing in practical approaches to calf rearing. In this role, her goal is to help dairy producers, calf ranchers and industry professionals through training and implementing new calf health/rearing practices.

- Register online in advance
- Expedite your badge
- Download CVENT Events mobile app
- Mark your calendars for upcoming events

**DON'T  
FORGET!**

**CENTRALPLAINSDAIRY.COM**

# SIoux DAIRY EQUIPMENT, INC.

General Contracting • Dairy Design • 24-Hour Service • Preventative Maintenance • [www.siouxdairy.com](http://www.siouxdairy.com) • 800.962.4346



Established in 1987, Sioux Dairy Equipment, Inc. is a detail-oriented dairy equipment company and general contractor who specializes in building customized turnkey dairy facilities. We have the ability to back any dairy with our 24/7/365 service, preventative maintenance, chemical, and bulk supplies. With the experience of constructing and servicing dairy facilities ranging from 100 to 10,000 cows, we feel confident in being able to make your project a success. Call us today to learn more about what we can do for you.



MORNING AgClips  
AMERICA'S #1 AG NEWS SOURCE

**SOMETHING  
TO CROW  
ABOUT!**



Stay up to date  
with your local  
and national  
ag news!

**SCAN THE CODE  
TO SIGN  
UP!**



## ABOUT US

Morning Ag Clips sends out breaking local and national agricultural news every day.

## FIND US

In your inbox  
On our  
Website  
On our App



## WE DELIVER

In your inbox  
Monday through  
Saturday. Read  
the Clips in the  
cab or behind a  
computer. We go  
everywhere.



[www.MorningAgClips.com](http://www.MorningAgClips.com)



[@MorningAgClips](https://twitter.com/MorningAgClips)

*American's #1 Daily Ag News Source*



# BREAKOUT SESSIONS

## Credit for Good:

### Producer Pathways to Profit for Sustainable Practices

SPONSORED BY:

**Elanco**

## Session Description:

The vision to turn sustainability into an opportunity for dairy farmers begins with solutions and tools that reduce environmental impact, then recognizing these efforts by quantifying them through analytical services and partnerships designed to turn these quantifications into assets that can be certified and sold to consumer-packaged goods companies working to meet their climate neutrality goals. Kvidera will cover why ruminants are so sustainable to begin with, an overview of greenhouse gas emissions in the dairy industry today, the future of enteric methane solutions and how this will ultimately result in economic sustainability for the dairy producer.



## Meet the Presenters: Sara Kvidera & Kevin Dhuyvetter

### *Sara Kvidera - Dairy Sustainability Technical Lead | Elanco Animal Health*

Sara Kvidera is the dairy sustainability technical lead at Elanco Animal Health. Kvidera grew up on a row-crop and beef cow-calf farm in Iowa. She attended Kansas State University for her bachelor's degree and completed a PhD in nutritional science at Iowa State University in 2017. Kvidera has studied and published in areas related to dairy cow metabolism, heat stress, inflammation, feed additives and gut health. She has worked as a technical consultant in the industry since 2017 and joined Elanco Animal Health in April of 2021, where she is responsible for providing technical support around feed additives and sustainability.

### *Kevin Dhuyvetter - Dairy Technical Consultant | Elanco Animal Health*

Kevin Dhuyvetter is the distinguished technical advisor for Elanco Animal Health's U.S. Dairy Business Unit, with responsibility for providing technical support to U.S. dairy producers and key influencers on economic-related issues in the dairy industry. His primary focus is to analyze factors affecting profitability of dairy operations, developing decision tools and analyzing herd health, production and economic data. In the last several years, he has also been involved with Elanco's UpLook platform for quantifying carbon emissions and emission reductions on dairies. Prior to joining Elanco in 2014, Dhuyvetter spent 27 years with Kansas State University - working as an extension specialist and research economist, where he focused on leasing and buying land, machinery costs, crop and livestock production economics, marketing and technology adoption. Dhuyvetter received his bachelor's, master's and PhD degrees from North Dakota State University, Iowa State University and Kansas State University, respectively, all in agricultural economics.

# BREAKOUT SESSIONS

## Calf Scours Continues to be a Prevailing Problem in Calves... A New Treatment Strategy Proves Successful!

SPONSORED BY:



### Session Description:

Calf scours accounts for approximately 50-60% of preweaned heifer deaths and is a prevailing problem in many operations. While many treatment modalities have been attempted, few have proven successful. Two problems exist when a calf succumbs to scours, dehydration and significant tissue damage to the gastrointestinal tract. While various calf products have been developed to treat scours, none directly address both dehydration and tissue damage in a disruptive way. Bovine colostrum has repeatedly shown efficacy in the treatment of human gastrointestinal diseases.



### Meet the Presenter: Michael Nagorske

*Owner | ProGen Cattle Solutions*

Michael Nagorske grew up on a grain and cattle operation in Southwestern Minnesota, which continues to operate today. He is co-owner of Nagorske Brothers Angus, which provides seedstock to commercial and registered breeders throughout the United States. He attended veterinary school at the University of Minnesota and started working for Trans Ova Genetics at the beginning of his veterinary career. He served on the Professional Services Team and performed procedures associated with assisted reproductive technologies as it related to embryo transfer and in vitro fertilization in beef and dairy production systems. This is where he found a deep passion for raising calves and served as director for the Veterinary Services Team, which was responsible for managing health and performance of the Elite Calf program's youngstock, Viagen Cloning program and Genetic Advancements Center's heifer program. Nagorske also served as director of research for SCCL, where he collaborated on many calf studies with researchers throughout the world. He currently owns and operates ProGen Cattle Solutions, a calf consulting and nutrition service, where he provides consultation for dairy and calf ranch operations in the United States.

# BREAKOUT SESSIONS

## The Sweet Spot: How Molasses Complements Adult Cow Rations

SPONSORED BY:



### Session Description:

Explore the role of molasses and liquid feeds in dairy rations, highlighting their benefits for forage digestion, reduced sorting behavior and overall cow performance.



### Meet the Presenter: Gail Carpenter

*Assistant Professor and Dairy Extension Specialist | Iowa State University*

Gail Carpenter is an assistant professor and state dairy extension specialist at Iowa State University. Carpenter is a native of Central Michigan and attended Michigan State University for her bachelor's degree, the University of Minnesota for her master's degree and Kansas State University for her PhD. She has worked as an assistant professor at the University of Guelph Ridgetown Campus and a dairy nutritionist with CSA Animal Nutrition in Dayton, Ohio, before beginning at Iowa State in 2021. Carpenter's role includes extension, research and teaching, and she focuses on applied nutrition and management strategies for productive dairy herds in each of these roles.

## FREE DONUTS

WEDNESDAY, MARCH 26 - 8:00AM

LOCATED IN THE ARENA AT THE  
VALLEY QUEEN CHEESE DAIRY BAR

Thank you to our sponsors:



# BREAKOUT SESSIONS

## Goldilocks:

### How Much Gut Health Technologies is 'Just Right'?

*Farmer-Owned*

SPONSORED BY: **LAND O LAKES®**

#### Session Description:

With so many gut health technologies available for calves, it's getting hard to know what's "too much" and what is "too little." The presenter will uncover some potential problematic scenarios and leave listeners with questions to guide their future decisions regarding "Is this the right product for me and my calves?"



#### Meet the Presenter: Jill Soderstrom

*Dairy Young Animal Solutions Specialist | Land O'Lakes*

Jill Soderstrom has a passion for improving animal well-being and performance through supporting health and optimizing the gut microbiome. She has an interest in working with calves, since early life is when you can have your greatest impact on optimizing dairy cow performance. With these goals in mind, she joined the Technical Innovations Team at Land O'Lakes as a dairy young animal solutions specialist in November 2018. Her role involves supporting the U.S. sales teams for Land O'Lakes and Calva milk replacers and calf care technologies, as well as being part of the Milk Replacer Research & Product Development Team. Previously, Soderstrom worked for an animal health company - supporting the West U.S. sales team that sold probiotics and silage inoculants for dairy cows. Soderstrom grew up in California, attending the University of California-Davis for her master's degree and PhD in animal biology. Her research focused on dairy cattle nutrition and behavior.



Thank you to all  
our sponsors!

# Select Sires Member Cooperative delivers excellence in personalized service, quality offerings and cattle genetics.

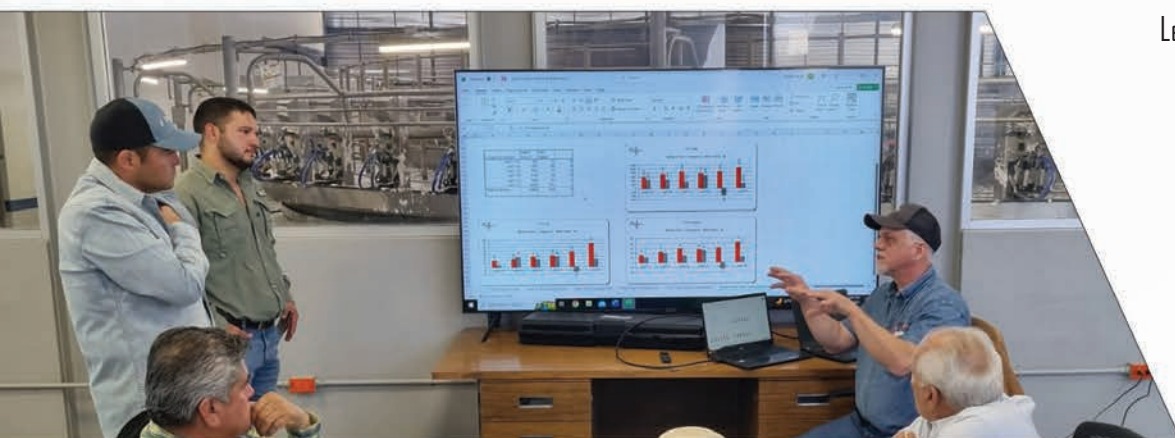

- Genetic and Reproductive Solutions
-  CowManager<sup>®</sup> Herd Monitoring System
- ProfitSOURCE<sup>®</sup> – Beef on Dairy Genetics
- NxGEN<sup>®</sup> – Early Genetic Gain
- HHP\$<sup>®</sup> – Increased Herd Life

**We value relationships and prioritize fact-driven insights to help our customers and our team achieve long-term results.**

Learn more about our genetic lineup, product offerings and services by scanning the QR code below!



**SELECT SIRES  
MEMBER  
COOPERATIVE**



Call your representative to protect your herd's health and your bottom line!

Phone: (614) 878-5333 ♦ Web: [www.ssmcoop.com](http://www.ssmcoop.com)

©ProfitSOURCE, NxGEN and HHP\$ are registered trademarks of Select Sires Inc., Plain City, OH.  
CowManager is a registered trademark of Agis Automatisering, Utrecht, Netherlands.

# SESIONES DE TRABAJO EN ESPAÑOL

## Milk Quality, Mastitis and Parlor Interactions

## Calidad de Leche, Mastitis y Maquinaria de Ordeño

SPONSORED BY: **zoetis**

### Session Description:

The objective of this workshop is to explain why milk quality and mastitis are critical for the consumer and how everybody that works at a dairy has a responsibility in this endeavor. Learn why compliance to milking protocols and following basic cow comfort and hygiene guidelines are critical for cow health, dairy well-being and consumer satisfaction. Properly working equipment and maintenance of the milking parlor contribute to the production of quality milk. This milk quality, mastitis and equipment workshop will focus on easy-to-implement management strategies, basic hygiene practices and monitoring strategies that can significantly decrease mastitis risk, improve milk quality and maintain properly working equipment.

El objetivo de este taller es explicar porque la calidad de leche y la mastitis son criticas para el consumidor, y como todos los que trabajan en una lecheria son responsables de esta tarea. Aprenda porque seguir las rutinas de ordeño, seguir reglas basicas de comfort para la vaca y la higiene son criticas para la salud de la vaca, el bienestar de la lecheria y la satisfaccion del consumidor. Equipo de ordeño que trabaja adecuadamente y que se le da mantenimiento contribuye a la produccion de leche de calidad. El taller de calidad de leche, mastitis y maquinaria de ordeño se enfocara en practicas de manejo faciles de implementar, practicas basicas de higiene y estrategias de monitoreo que nos ayudaran a disminuir el riesgo de la mastitis y el mejoramiento de la calidad de la leche y el buen funcionamiento del equipo de ordeño.

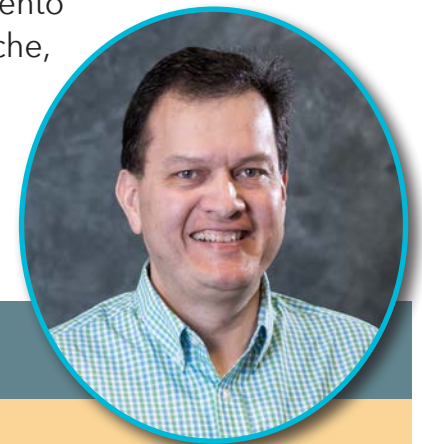

### Meet the Presenter: Jorge Luna

*Senior Dairy Production Specialist | Zoetis*

A Zoetis Dairy Production Specialist dairy team member, Jorge Luna supports veterinarians and dairy producers in Minnesota and South Dakota. His areas of focus include protocol development/implementation and Hispanic training in the areas of reproduction, production, fresh cow health and transition management. Previously, Luna worked in California as a territory manager for Pharmacia Animal Health. He has also worked in Idaho and Mexico as a fresh cow reproduction manager for Pfizer Animal Health. Luna received his bachelor's degree at the University of Arizona. He then went on to complete his master's degree at the University of Arizona in reproductive physiology. From 1998-2000, he worked under Jim Cullor at the Dairy Food Safety Lab.

# SESIONES DE TRABAJO EN ESPAÑOL

## The 7 Pillars for Raising a Healthy Calf

## Los 7 Pilares para Criar Becerras Saludables

SPONSORED BY:  **MERCK**  
Animal Health

### Session Description:

This presentation will provide attendees with practical management strategies to raise healthy dairy calves. It will cover key aspects to better prepare calves for environmental challenges - starting from fetal development through the critical transition to the post-weaning phase.

Esta presentación ofrecerá a los asistentes estrategias prácticas de manejo para criar becerras lecheras saludables. Se abordarán aspectos clave para preparar mejor a las becerras frente a los desafíos ambientales, comenzando desde el desarrollo fetal hasta la transición crítica a la fase posterior al destete.

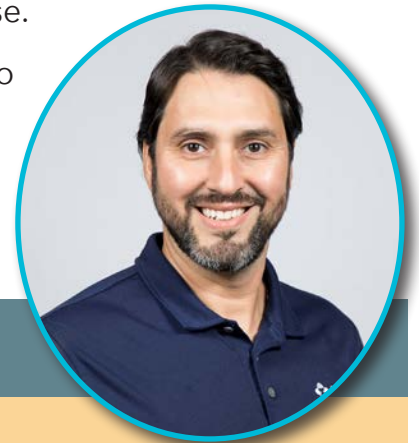

### Meet the Presenter: Tiago Tomazi

*Bovine Technical Services Veterinarian | Merck Animal Health*

Tiago Tomazi is a veterinarian who graduated from the University of Passo Fundo in Brazil. He completed both his master's degree and PhD at the University of São Paulo, where he also worked as a research assistant. During his PhD program, Tomazi conducted part of his research at Cornell University's Quality Milk Production Services. Following this, he served as a postdoctoral associate in the department of population medicine and diagnostic sciences at Cornell University. In 2021, Tomazi joined the Technical Services team at Merck Animal Health. His professional focus has been on the epidemiology and control of infectious diseases in dairy cattle - contributing to advancements in herd health and milk quality.

Tiago Tomazi es veterinario, egresado de la Universidad de Passo Fundo en Brasil. Completó tanto su maestría como su doctorado en la Universidad de São Paulo, donde también trabajó como asistente de investigación. Durante su programa de doctorado, Dr. Tomazi realizó parte de su investigación en el Quality Milk Production Services de la Universidad de Cornell. Posteriormente, se desempeñó como investigador postdoctoral en el Departamento de Medicina Poblacional y Ciencias Diagnósticas en la misma universidad. En 2021, Dr. Tomazi se unió al equipo de Servicios Técnicos de Merck Animal Health. Su enfoque profesional se ha centrado en la epidemiología y el control de enfermedades infecciosas en ganado lechero, contribuyendo a los avances en la salud de los hatos y la calidad de la leche.

# SESIONES DE TRABAJO EN ESPAÑOL

## The Importance of Your Role as a Dairy Worker in the Sustainability of the Dairy Industry

## La importancia de su papel como trabajador de las lecherías en la sostenibilidad.

SPONSORED BY: 



### Meet the Presenter: Jorge Delgado

*Training, Talent Development and Retention Program  
for Dairy Workers Leader | Alltech*

Jorge Delgado leads the Alltech Training, Talent Development and Retention Program as part of the Alltech On-Farm Support program. He previously served as a dairy specialist and uses his expertise to help dairy producers with employee management practices, herd health, milk quality, calf management, protocol customization and animal welfare. Originally from Ecuador, Delgado comes from a family of dairy farmers. He received his bachelor's degree in agriculture and dairy science from EARTH University in Costa Rica. Afterward, he returned to Ecuador, where he worked in the dairy industry to represent a genetics company through consulting, sales and training. In 2002, Delgado moved to the United States, where he worked 10 years on multiple dairies as a herd manager. He has also worked with Elanco's dairy training program, focusing on empowering dairy workers.

Jorge Delgado lidera el área de Capacitación, Desarrollo de Talento y Programa de Retención (T2R) como parte del Programa de Apoyo a lecherías de Alltech. Anteriormente se desempeñó como especialista en lecherías y utiliza su experiencia para ayudar a los productores lecheros con prácticas de manejo de empleados, salud animal, calidad de leche, manejo de terneros, personalización de protocolos, bienestar animal, entre otros. Originario de Ecuador, Delgado proviene de una familia de productores lecheros. Recibió su licenciatura en agricultura y ciencias lecheras de la Universidad EARTH en Costa Rica. Posteriormente, regresó a Ecuador, en donde trabajó en la industria lechera para representar a una empresa de genética bovina a través de consultoría, ventas y capacitación técnica. En el 2002, Delgado se mudó a los Estados Unidos, en donde trabajó durante 10 años en varias lecherías como gerente. También trabajó con el Programa de Capacitación de lecherías de Elanco, enfocándose en empoderar a los trabajadores de la industria lechera.



# SESIONES DE TRABAJO EN ESPAÑOL

## Session Description:

Sustainability seems to be the buzzword, especially in the agricultural industry. You may have heard this word from your employer, your supervisor or a colleague. Possibly, you saw it in an advertisement. Everywhere we look, there is some activity, product, project, etc. attached to the word "sustainability." While some would think it is overuse of a catchy word, it really makes you wonder if it's a marketing tool or if we're really contributing to sustainable agriculture. The most important question is, what does sustainability mean? During this session, the presenters will explain the basic concepts of sustainability and the role you play in this important industry movement.

La sostenibilidad parece ser la palabra de moda, especialmente en la industria agrícola. Es posible que haya escuchado esta palabra de su empleador, su supervisor, un colega o la haya visto en un anuncio. Dondequiera que miremos, hay alguna actividad, producto, proyecto, etc. asociado a la palabra "sostenibilidad." Si bien algunos pensarían que es el uso excesivo de una palabra pegajosa, realmente hace que se pregunte si es una herramienta de mercadeo o si realmente estamos contribuyendo a la agricultura sostenible. La pregunta más importante es, ¿qué significa sostenibilidad? Durante esta sesión, Sebastián Mejía Turcios y Jorge Delgado explicarán los conceptos básicos de la sostenibilidad y el papel que juegan en este importante movimiento de la industria.

## Meet the Presenter: Sebastián Mejía Turcios

### *On Farm Support - Beef Specialist | Alltech*

Sebastian Mejía es un especialista en apoyo en la granja en Alltech con un enfoque en las ganaderías. En este puesto, se relaciona activamente con otros niveles de la industria de la carne en temas relacionados con la sostenibilidad. A Mejía Turcios le apasiona compartir su conocimiento e investigación con líderes de la industria, productores, educadores y otras partes interesadas en la agricultura animal. Nacido y criado en Honduras, Mejía Turcios se involucró en la agricultura a una edad temprana, con un amor particular por la ganadería, que eventualmente se convirtió en el enfoque de sus estudios. Obtuvo una licenciatura en agronomía de la Universidad EARTH en Costa Rica y una maestría en ciencia animal de la Universidad Tecnológica de Texas. Mejía Turcios completó su doctorado en junio de 2024 en la Universidad de California, Davis, bajo la dirección del Dr. Frank Mitloehner, profesor de agricultura animal de renombre internacional que también es experto en calidad del aire y director del Centro CLEAR de UC Davis.



# SESIONES DE TRABAJO EN ESPANOL

## Enhancing Biosecurity on Dairy Farms: Practical Tips for Dairy Workers

## Bioseguridad en las Granjas Lecheras: Consejos Prácticos para los trabajadores

SPONSORED BY:



SOUTH DAKOTA  
STATE UNIVERSITY

### Session Description:

Implementing biosecurity practices in dairies is essential to safeguarding the health of both animals and workers. Disease outbreaks can have devastating consequences - not only for farm productivity but also for the well-being of employees and surrounding communities. This training workshop will provide Hispanic dairy workers with the knowledge and tools necessary to strengthen biosecurity measures, reduce disease risks and create a safer working environment.

### Descripción de la Sesión

La implementación de prácticas de bioseguridad en las granjas lecheras es esencial para proteger la salud tanto de los animales como de los trabajadores. Los brotes de enfermedades pueden tener consecuencias devastadoras, no solo para la productividad de la granja, sino también para el bienestar de los empleados y las comunidades cercanas. Este taller de capacitación proporcionará a los trabajadores hispanos el conocimiento y las herramientas necesarias para fortalecer las medidas de bioseguridad, reducir los riesgos de enfermedades y crear un entorno de trabajo más seguro.



DOWNLOAD THE MOBILE APP  
"Cvent Events"

- 1 Search Cvent Events in your app store
- 2 Download app
- 3 Search Central Plains Dairy Expo
- 4 **stay up to date on the latest expo news, activities, sessions, events & more!**

# SESIONES DE TRABAJO EN ESPANOL

## Meet the Presenter: Maristela Rovai

*Training, Talent Development and Retention Program Associate  
Professor/Extension Dairy Specialist | South Dakota State University*

Maristela Rovai is an associate professor and extension dairy specialist in the department of dairy and food science at South Dakota State University in Brookings, S.D. Rovai's work areas include milkability in dairy ruminants with a strong focus on milking technology, milk quality improvement, mastitis, calf growth and dairy workers' well-being.



## Meet the Presenter: Noelia Silva del Rio

*Dairy Herd Health Specialist | University of California-Davis School of Veterinary Medicine*

Noelia Silva del Rio has served as the dairy herd health specialist at the University of California-Davis School of Veterinary Medicine since 2012. Previously, she was the dairy advisor in Tulare County (California) for three years. She is located at the Veterinary Teaching and Research Center, a satellite unit of the veterinary school in Tulare County. She obtained her Doctor of Veterinary Medicine degree from Spain and her PhD in dairy nutrition and reproductive physiology from the University of Wisconsin-Madison. Her research interests encompass transition cow and calf health, dairy herd sustainability and animal welfare. Additionally, she is deeply interested in improving dairy worker performance and developing tools to motivate positive changes in dairy operations.



## FREE PANCAKE BREAKFAST

THURSDAY, MARCH 27 - 8:00AM  
LOCATED IN THE ARENA

Thank you to our sponsor:



# Get Your Golf On!

Keep your eyes peeled at Expo and invite  
Producer Hot Shots that will help your team win big!  
Register your team and get your clubs ready.

This is an outing you don't want to miss!

**JULY 30, 2025**  
**ROCKY RUN**  
**GOLF COURSE**  
**DELL RAPIDS, SOUTH DAKOTA**





Registration will be open on  
**March 1st!**

Sign up for the Newsletter:  
<https://www.centralplainsdairy.com/emoos/>  
Or stay updated on our site:  
<https://www.centralplainsdairy.com/golf-outing/>

# ED SHED IN ARENA

## Shedding Light on Stray Voltage: Understanding and Solving a Hidden Dairy Challenge

SPONSORED BY: ZERO TOLERANCE/CURRENT DEFENSE

### Session Description:

Stray voltage remains a critical yet often misunderstood issue in the dairy industry. It impacts cow health, milk production and farm profitability. This presentation explores the causes and effects of stray voltage, innovative detection methods and practical approaches for remediation. Gain insights into new developments that are reshaping the way stray voltage is understood and managed to improve animal welfare and farm performance.



### Meet the Presenter: James Neawedde Jr.

*Director of Operations - Owner / Zero Tolerance*

James Neawedde is the director of operations at Zero Tolerance/Current Defense, driving innovation in the dairy industry through stray voltage mitigation and IoT-based solutions that enhance farm productivity and animal welfare. With more than 20 years of experience in global business development and manufacturing technologies, he has held key leadership roles at ABB, Panduit and Rockwell Automation. A published author and dynamic speaker, Neawedde specializes in topics like smart manufacturing, process optimization and advanced agricultural technologies. He holds a master's degree in physics from The University of Akron and certifications, including PMP and Six Sigma.

## FREE GRILLED CHEESE SANDWICHES

AT THE VALLEY QUEEN  
CHEESE DAIRY BAR

Thank you to our sponsors:





MWI Animal Health<sup>®</sup>  
cencora

# We provide innovative solutions to conquer your challenges

From your feed mill to your parlor,  
and everywhere in between



Learn more  
[mwiah.com/production-animal](https://mwiah.com/production-animal)

# ED SHED IN ARENA

## The Power of Multiple Modes of Action for Effective Pest Control

SPONSORED BY:  **MGK**<sup>®</sup>

### Session Description:

Insecticides are an important component in a balanced pest control program. With several formulations, ingredients and modes of action (MoA) available, it can be difficult to know which product to choose and how best to use it. Relying on a single MoA can lead to resistance, allowing tolerant pests to survive and pass on resistance traits. By using multiple MoA in rotation or combination, we can combat the development of resistance. This session is an opportunity to discover how multiple MoA provides effective and comprehensive pest control.



### Meet the Presenter: Anna Hansen

*Technical Services Support Specialist / MGK*

Anna Hansen is a technical service support specialist at MGK. She received her bachelor's degree at Concordia College in Moorhead, Minn., where she majored in biology and German. She graduated with her master's degree in entomology from the University of Minnesota. After graduating, she worked in the pest control industry as both a technician and quality assurance/training coordinator.



## BEER GARDEN

LOCATED ON THE NORTH  
END BETWEEN CONVENTION  
CENTER AND ARENA

Thank you to our sponsor:

 **Alltech**<sup>®</sup>



## Cool Cows, Thriving Herds: Advanced Heat Mitigation Techniques

SPONSORED BY:



### Session Description:

Heat stress significantly impacts the dairy industry, affecting cow performance and a dairy operation's bottom line. Effective abatement strategies, management adjustments and ration strategies are crucial. Join Bill Stone to explore innovative solutions and approaches to help your cows stay productive and cool while battling the marathon of heat stress season.



### Meet the Presenter: Bill Stone

#### *Technical Services and Research / Diamond V*

Bill Stone grew up on a beef and hog farm in southeastern Wisconsin. He received a veterinary degree from the University of Wisconsin-Madison. After practicing for three years as a dairy veterinarian, he entered graduate school in dairy cattle nutrition and management at Cornell University and obtained a PhD. Stone operated his own dairy nutrition and management consulting business for several years in Central New York State before joining the PRO-DAIRY program. This state-wide extension position allowed him to actively work in a continuing education role with producers, nutrition consultants and veterinarians in the areas of dairy herd management and nutrition. His main areas of focus and research have included forage management, rumen acidosis and approaches to reducing variation in dairy feeding programs. Stone joined Diamond V in 2007, with responsibilities in dairy technical services, particularly relating to dairy cattle nutrition and management, and with the Diamond V research program.

# ED SHED IN ARENA

## Forage 360: Producing Forage Year Round

SPONSORED BY: **LAND O' LAKES, INC.**

### Session Description:

Livestock producers are continually looking for ways to maximize the opportunity to grow feed and apply manure on crop acres. Adopting a "forage system" to economically and strategically "grow more with less" is a mindset all should engage. Crop rotation in a forage system is a unique opportunity to utilize multiple crops on the same acres in rotation to produce forages the entire growing season. An example is corn silage, winter wheat-forage, forage sorghum followed by spring-seeded alfalfa. This can maximize the sun's energy with virtually no downtime in fallow acres.



### Meet the Presenter: Jeff Jackson

*Alfalfa and Forage Specialist and National Product Manager for Forage Sorghum / WinField United*

Jeff Jackson grew up on a moderate-sized livestock/row-crop operation in Northwest Iowa with corn, soybeans, oats, alfalfa, cattle, hogs, sheep and horses. South Dakota State University was the next destination where he earned a bachelor's degree in animal science and a master's degree in plant science before going back to the country. Starting his ag career as an applicator/feed guy/agronomist/jack of all trades at the local co-op opened many doors and enhanced his academic career. An opportunity in 2005 led Jackson to CROPLAN as a seed district sales manager. Working in a heavy dairy area of I-29 in eastern South Dakota led to his current position in 2010 with WinField United as an alfalfa and forage specialist and national product manager for forage sorghum. He continues to focus on alfalfa, corn silage, triticale, grain sorghum/milo and forage sorghum technical support and training opportunities for industry professionals and growers alike. Product management of a CROPLAN triticale business has been the latest project for him. Jackson's time primarily focuses on work with customers in Western Minnesota, Eastern South Dakota and North Dakota, Nebraska and Kansas, but he also makes rounds in Missouri and Iowa, and occasional visits to larger herds in Texas, New Mexico and Arizona.

# THANK YOU FOOD SPONSORS!



## FREE GRILLED CHEESE SANDWICHES

Sponsored by AMPI, at the Valley Queen Cheese Dairy Bar, located in the Arena's northeast concession stand



## BEER GARDEN

Sponsored by Alltech



## FREE COFFEE

On Wednesday and Thursday in the Arena



## FREE PANCAKE BREAKFAST

On Thursday, March 27, in the Arena at 8:00 a.m.



## FREE DONUTS

On Wednesday, March 26, at the Valley Queen Cheese Dairy Bar



MORNING AgClips  
AMERICA'S #1 AG NEWS SOURCE

## FREE ICE CREAM TREATS

at the Valley Queen Cheese Dairy Bar

WELLS ENTERPRISES

## WINE & CHEESE SOCIAL

On the trade show floor, Wednesday, March 26, at 4:30 p.m.



## Turning Waste into Wealth:

### Transforming Farm Manure into a Low-cost Fertigation Asset for In-season Application with Drip Irrigation

SPONSORED BY:



### Session Description:

NutraDrip started as an irrigation company, but the owners soon noticed the value of running nutrients through drip lines to feed crops at the root level. NutraDrip Irrigation Systems began with synthetic fertilizers but realized that livestock operations, like dairies, have huge potential on their farms to apply in-season nutrients after the product is separated. NutraDrip executives have worked for three years on this and now offer an exceptional low-cost solution.



### Meet the Presenter: Kurt Grimm

#### *CEO and Research / NutraDrip Irrigation Systems*

Kurt Grimm is the CEO at NutraDrip Irrigation and the head of research for manure, irrigation and agronomy, with a focus on dairies and high-yielding producers. He grew up around his family's hydroponic farm and was intrigued with the amount of control a hydroponic system offered a vegetable grower. While the family business shifted from tomatoes to a full nursery and landscape operation, that intrigue never left him. Flash forward to 2012. A drought hit Northeast Kansas and Grimm and his brothers were farming an odd-shaped field that needed water. The typical pivot irrigation system wouldn't work and they began looking into other options. The brothers' experience in the landscape and nursery business familiarized them with drip irrigation. So, they gave it a shot, installing drip irrigation in the field themselves. It was then that the light bulb went off. Drip irrigation reminded Grimm of the hydroponic system he had grown tomatoes in as a kid. Both systems offered total control to the grower - not just in the amount of water a person could apply but also what could be added to that water for plant health. This level of control, of integrating a plant's water and nutrient needs together in a subsurface drip irrigation system, had been around for several years in the vegetable and greenhouse industries. Finding a subsurface drip irrigation system (SDI) that would work for corn or soybean fields was difficult. Just as they had to install that first field themselves, the brothers decided to create a company that would install SDI systems for other growers: NutraDrip Irrigation Systems.

## SRP Technology and an Experimental Salmonella Dublin Vaccine

SPONSORED BY:



### Session Description:

Salmonellosis has been a dairy industry concern for more than 20 years. In recent times, attention has shifted to the Dublin serotype of Salmonella enterica. In addition to hygiene practices, vaccination is a tool for use in a disease management plan. Trials conducted with Vaxxon SRP Salmonella and an experimental SRP Dublin have helped shape the understanding of how this subunit vaccine technology works.



### Meet the Presenter: Jason Anderson

*Technical Services Veterinarian-Bovine / Vaxxino*

Jason Anderson completed his training at the University of Minnesota - obtaining a bachelor's degree in veterinary science and a Doctor of Veterinary Medicine degree. In private practice, he worked as a food animal veterinarian for 13 years - focusing on dairy and beef cow/calf production medicine. Anderson joined Vaxxino as a technical services veterinarian in May of 2022 and covers the Upper Midwest and the northern states of the Southeast.

- Register online in advance
- Expedite your badge
- Download CVENT Events mobile app
- Mark your calendars for upcoming events

DON'T FORGET!

[CENTRALPLAINSDAIRY.COM](http://CENTRALPLAINSDAIRY.COM)

# NEW PRODUCTS!

## EIGHT COLORS OF BIBS

4-D AG Fashion

806-656-1646

[elizabeth@4dagfashion.com](mailto:elizabeth@4dagfashion.com)

<https://4dagfashion.com>

4-D AG Fashion introduces its expanded collection. In just one year, the business has added three new bib colors and prints, including stylish cow print, bold maroon red and trendy camo print. Additionally, their calf jackets now feature a USA flag print – perfect for celebrating your patriotism. Discover the best in comfort and style with 4-D AG Fashion's latest offerings.



## THE CALF HERO X

Golden Calf Company LLC

715-318-0897

[care@goldencalfcompany.com](mailto:care@goldencalfcompany.com)

[www.goldencalfcompany.com](http://www.goldencalfcompany.com)

Golden Calf Company introduces a new generation of Calf Hero colostrum warmers and pasteurizers. The new Generation X delivers outstanding performance at a more affordable price point. Building on the success of previous models, the new Calf Hero X series simplifies maintenance, enhances efficiency and improves eco-friendliness in a cost-effective manner.

## ATLAS 74 & CX74

Munters

800-277-2376

[foodtech@munters.com](mailto:foodtech@munters.com)

<https://www.munters.com>

The Atlas 74 – with the new Munters Drive G2 MAX EC Motor – sets new industry standards for performance and durability. The advanced design of the CX74 housing and propeller produces a large volume of air and a high centerline velocity, exceeding any other fan in its class. Together, they will take your dairy herd's milk production to new heights.

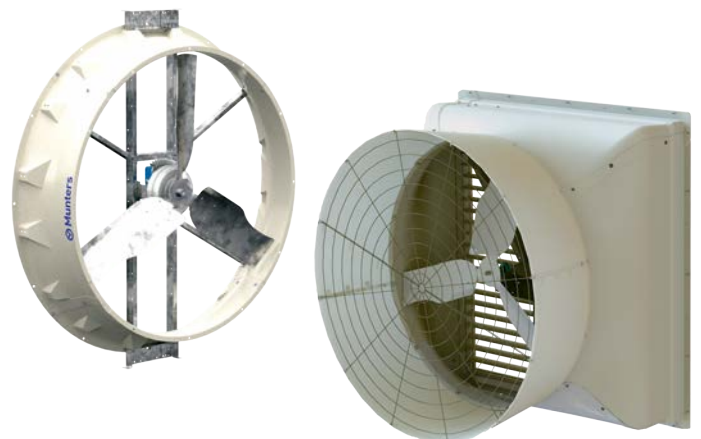

# NEW PRODUCTS!

## AGRI-GRID SAND SAVER 2.0 WITH LOK-SEAL SYSTEM

Agri-Comfort  
888-231-3575  
martin@agri-comfort.com  
<https://agri-comfort.com>

The Agri-Grid Sand Saver 2.0 with Lok-Seal System optimizes dairy cow bedding, which reduces sand use by up to 50%. Its unique grid keeps the bed level – minimizing maintenance. The Lok-Seal System's interlock prevents sand infiltration and ensures easy installation. It supports cows' hooves, improves lying position, boosts stall occupancy and reduces waste – offering a durable and efficient bedding.

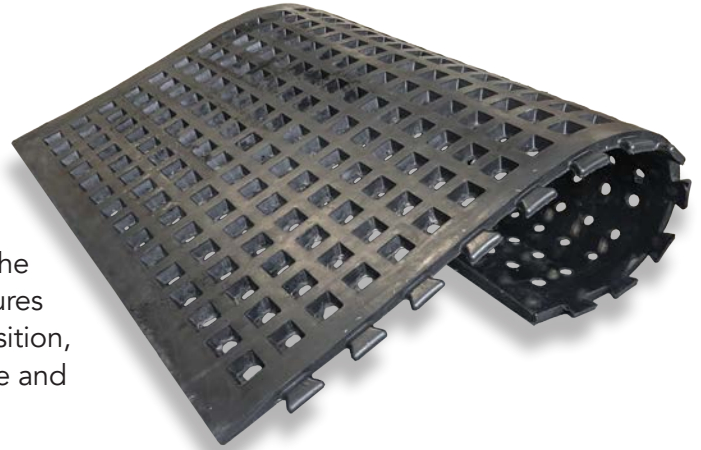

## RAPID STRIKE

Ralco  
507-337-6916  
ruminanthelp@ralcoagriculture.com  
<https://www.ralcoagriculture.com>

Rapid Strike is an oral drench designed to combat calf scours. Powered by Microfused Essential Oils and Actifibe Prebiotic, it provides a natural solution to support calf health during digestive stress. Rapid Strike reduces pathogen load, promotes gut health and restores normal eating and drinking patterns – offering an effective alternative to antibiotic treatments.

## CENTRAL VALLEY DAIRY SUPPLY COLLABORATES WITH NUAGE BUILDERS

Central Valley Dairy Supply and NuAge Builders  
605-467-0812  
centralvalleydairy@yahoo.com  
[www.cvdssd.com](http://www.cvdssd.com)

NuAge offers ideal building options for your next project. Central Valley Dairy Supply (CVDS) provides premium equipment. The skilled teams of these businesses complete projects with meticulous attention to detail and on time. CVDS plans to grow with NuAge Builders and give all clients state-of-the-art turnkey solutions. Stop by the CVDS or NuAge booth for more details.



# NEW PRODUCTS!

## BLUELITE REPLENISH AB+

TechMix  
320-562-2740  
[info@techmixglobal.com](mailto:info@techmixglobal.com)  
[www.techmixglobal.com](http://www.techmixglobal.com)

TechMix launched BlueLite Replenish Ab+. This new product is built on TechMix's highly effective BlueLite Replenish electrolyte technology combined with bioactive compounds from colostrum. This synergy of ingredients helps stabilize and buffer the enteric environment and inhibit bacterial and viral challenges that are the leading causes of scours in calves.



## BIOEDGE DEFEND

QualiTech, LLC  
952-448-5151  
[info@qualitechco.com](mailto:info@qualitechco.com)  
<http://qualitechco.com>



Heat stress favors the development of inflamed intestine, which wastes nutrients and energy on immune tissue proliferation at the expense of growth. The Fennel in BioEdge Defend counteracts this effect by reducing metabolic heat production, reducing tissue inflammation and improving the gut's ability to serve as a barrier to intestinal pathogens and as an absorptive surface for nutrients.

## SILOSTOP COMPLETE

Silostop  
716-628-2528  
[sales@silostop.com](mailto:sales@silostop.com)  
[www.silostop.com](http://www.silostop.com)

Silostop Complete is a UV-stable, extremely tough, 6-mil, single-piece, high-oxygen barrier (HOB) silage film with an industry-leading oxygen transmission rate of less than 0.2 cm<sup>3</sup>/m<sup>2</sup>/24 hours. Silostop Complete does not need additional covers or netting to protect it from hail and wildlife damage. It is fully recyclable, with no nylon threads that unravel. Save labor costs and time with Silo Complete.





# ASCEND TO THE SUMMIT

Dairy Calf & Heifer Association  
Annual Conference & Trade Show  
April 8-10, 2025  
Westminster, Colorado



*All sessions will have live Spanish interpretation; both in-person and virtually*

## Sessions and Tours

- Wet calf track
- Post-weaned heifer track
- Beef cross track
- General Sessions to encourage and grow your business

## Trade Show Includes:

- Up to 60 exhibitors
- Focus on dairy calf and heifer specific products
- Producer focused

## Become a Member

- Access to the DCHA Gold Standards that contains third party researched data on calf and heifer performance.
- Recordings of past webinars and conference sessions: available exclusively to DCHA members when they log in to their member site.
- Networking opportunities to partner on research, product development, job postings, direct connections to calf raisers, etc.



APRIL 8-10, 2025 | Westminster, Colorado

**DCHA** DAIRY CALF  
& HEIFER  
ASSOCIATION

[www.calfandheifer.org](http://www.calfandheifer.org)





2025

# Dairy Beef Short Course

In collaboration with

IOWA STATE UNIVERSITY  
Extension and Outreach

**Tuesday, March 25, 2025 | 9:00 a.m. –3:15 p.m.**

**Denny Sanford Premier Center, Sioux Falls, South Dakota**

**SAVE THE DATE**

## AGENDA

9 a.m.	Registration– Taylor Leach Hildebrandt Assistant Editor with Dairy Herd Management will MC
9:30 a.m.	Zarchy Smith, SDSU — <b>Update on Implants</b>
10:15a.m.	Jennifer Spencer, Texas A&M — <b>Vaccination management</b>
11:00 a.m.	Gail Carpenter, ISU— <b>Calf management research “preparing ‘em for the feedlot”</b>
11:45 am	<b>Q&amp;A Session</b> — Taylor Leach Hildebrandt, moderating
12 noon	Lunch
12:45 p.m.	Garland Dalke, ISU — <b>What the Dairy Crossbreed Research Is Telling Us About The Feedlot</b>
1:30 p.m.	Melanie Pimentel-Concepcion, MSU — <b>Economics of BXD In The Feedlot</b>
2:15 pm	Sara Erickson, TELUS Agricultural— <b>Hoof related Lameness in Feedlot Cattle</b>
3:00 p.m.	<b>Q&amp;A Session</b> — Taylor Leach Hildebrandt, moderating
3:15 pm	Adjourn



SOUTH DAKOTA STATE UNIVERSITY EXTENSION



The registration fee is \$75 plus \$15 if a printed copy of the proceedings is desired. Student fee is \$20.  
On-line Registration: <https://go.iastate.edu/DBSC25> Deadline to register will be March 14  
For more information contact:

- Fred Hall, 712-737-4230
- Jim Salfer, 320-203-6093
- Gail Carpenter, 515-294-9085
- Madison Kovarna, 712-577-0606



This institution is an equal opportunity provider. For the full non-discrimination statement or accommodation inquiries, go to [www.extension.iastate.edu/diversity/ext](http://www.extension.iastate.edu/diversity/ext).



TARGETED NUTRITION  
**Blueprint**

**Targeted Nutrition for Peak Performance**

Explore the full Blueprint® Calf and Heifer Program  
[www.hubbardfeeds.com/species/dairy/calf-heifer](http://www.hubbardfeeds.com/species/dairy/calf-heifer)

Available where you buy **HUBBARD**  
an **MTech** company

Your **Feed Ingredient Link!**

WHAT YOU NEED WHEN YOU NEED IT. ON TIME & AT A PRICE THAT'S RIGHT



**American AGCO**  
Serving Agriculture Since 1936

CANOLA MEAL	RICE HULLS	SOY PLUS	SAWDUST
CORN GLUTEN FEED	SOYBEAN MEAL	FLAX SEED	LINSEED MEAL
CORN DISTILLERS GRAINS	SOY BEY	AMINO PLUS	NOVAMEAL
OAT HULLS	SOYBEAN HULLS	WHEAT MIDS	COTTONSEED

**Servicing THE Upper Midwest**

(MN, ND, SD, WI, IA, NE) <b>SEAN LASCHINGER</b> 3 800 836 5674 COTTONSEED & GRAIN BY PRODUCTS ✉ SLASCHINGER A AMERICANAGCO.COM	(MI, WI) <b>JOHN JOHNSON</b> 3 800 836 5646 COTTONSEED & GRAIN BY PRODUCTS ✉ JJOHNSON A AMERICANAGCO.COM
---	---

7900 97<sup>TH</sup> STREET SOUTH, COTTAGE GROVE, MN 55016  
FAX: 651 234 2351 WWW.AMERICANAGCO.COM

# NEW PRODUCTS!

## MASTERVET MASTER-WRAP

Armor Animal Health

800-255-1181

[salesupport@armorah.com](mailto:salesupport@armorah.com)

<https://www.armoranimalhealth.com>

Mastervet's Master-Wrap is a new hoof wrap designed with hoof trimmers and cow comfort in mind. A cohesive, flexible, non-slip bandage, Master-Wrap is made of strong fabric that tears straight and even. With a stretched dimension of 4 inches by 5 yards, it's a great addition to any hoof trimmer's lineup. Master-Wrap is available in fluorescent pink and fluorescent green – in 100-count boxes.



## MASTERVET CAL-MAX BOLUS

Armor Animal Health

800-255-1181

[salesupport@armorah.com](mailto:salesupport@armorah.com)

<https://www.armoranimalhealth.com>



Cal-Max is Mastervet's new calcium bolus for cows. Cal-Max is formulated for immediate and sustained release of calcium. Boluses contain calcium chloride and calcium sulfate. Calcium chloride has the greatest ability to support blood calcium concentrations, with high calcium bioavailability and the ability to invoke acid response in the cow – mobilizing more of her own calcium stores.

## YOUNGSTOCK MONITOR

CowManager

517-351-3180

[sales@cowmanager.com](mailto:sales@cowmanager.com)

<https://www.cowmanager.com>

CowManager launched Youngstock Monitor, a new comprehensive solution to monitor calf behavior. This innovative system provides real-time alerts for early disease detection and notifies producers when a calf may be falling behind its herdmates. With Youngstock Monitor and the new lightweight ear sensor, producers need just one sensor per animal for its entire lifetime – from calf to cow.

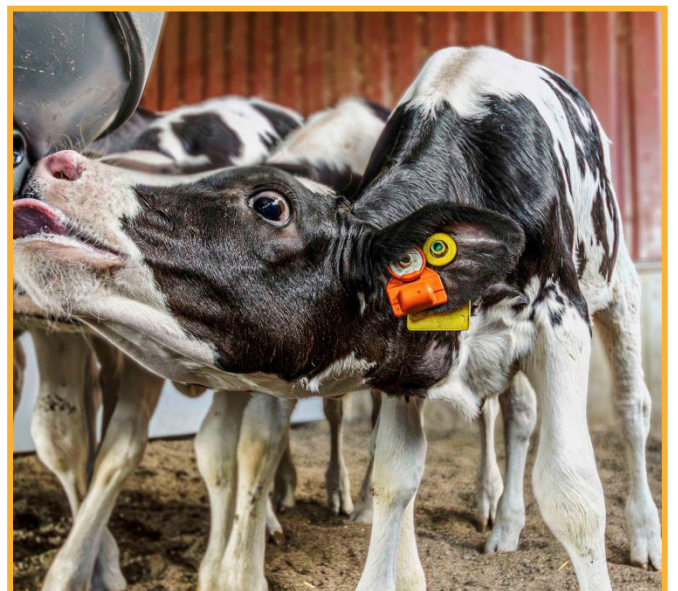

# NEW PRODUCTS!

## **SORT MY COW**

CowManager

517-351-3180

[sales@cowmanager.com](mailto:sales@cowmanager.com)

<https://www.cowmanager.com>

CowManager, the proven ear sensor monitoring system with more than 10 years of helping U.S. dairy producers improve cow management, introduces Sort my Cow. It is the newest sort gate technology that combines labor savings, technology integration and operational efficiency.

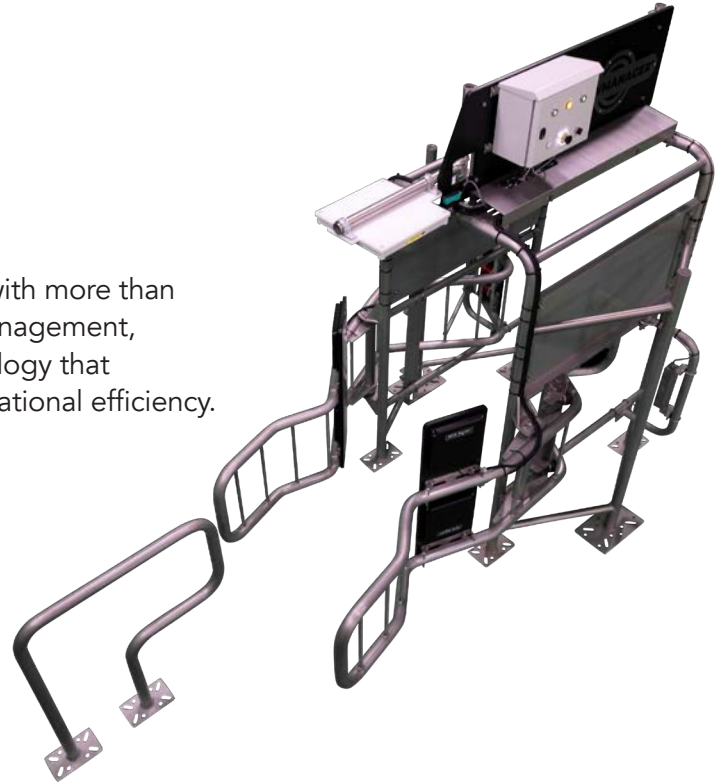

## **MEGAFAN 72 EC EXHAUST FAN**

SKOV-SECCO

450-771-0777

[naastrup@skov-secco.com](mailto:naastrup@skov-secco.com)

<http://www.skov-secco.com>

The MegaFan 72 wall fan revolutionizes dairy ventilation with advanced EC motor technology. Its integrated variable speed control enables precise fan speed adjustment from 80 to 400 RPM – maximizing performance and energy efficiency. At peak speed (400 RPM), the fan delivers 44,376 CFM while consuming 2,135 watts.



## **IMMUSTAT**

Form-A-Feed

800-422-3649

[conniefelton@formafeed.com](mailto:conniefelton@formafeed.com)

<https://www.formafeed.com>



ImmuStat is a revolutionary new product from Form-A-Feed – designed and demonstrated to help dairy cows modulate immune and inflammatory responses during the transition period. It benefits the cow by helping to modulate inflammatory pathway responses to stress factors – reducing the incidence of metabolic disorders and infectious diseases, and leading cows to higher productivity.

# IADG - A Leader in Agricultural Site Development



Locations



Resources



Projects



Incentives

Your search for the right community and dairy site deserves professional and confidential assistance. For 40 years, the Ag Team at Iowa Area Development Group has been an effective development partner for agribusiness in Iowa.

Contact the IADG Team for confidential and complimentary assistance

**Brian Tapp**, V.P. Value-Added Ag  
**btapp@iadg.com**  
**515.777.7309**

800.888.4743 | [www.IADG.com](http://www.IADG.com)



**NUTRITIONAL SCIENCES**

**NUTRITION MADE SIMPLE**

### WHO WE ARE

At the root, we are a research and development company. We translate the latest proven science into supplements that will improve the health and wellbeing for your livestock.

VISIT OUR WEBSITE AT  
[WWW.MBFEEDS.COM](http://WWW.MBFEEDS.COM) TO LEARN MORE.



**CALF PRODUCTS**

**TRANSITION COW PRODUCTS**

**FEED ADDITIVES**

# You're Invited!



**When-**  
 Wednesday 3-4:30 PM

**Where-**  
 Central Plains Dairy Expo  
 Beer Garden

**Why-**  
 Discover innovation. Explore our  
 turn key opportunities.



Excellence Redefined



# LAND O' LAKES, INC.

## MOVING THE DAIRY INDUSTRY FORWARD, *together.*

GROWING • FEEDING • PRODUCING  
PROCESSING • ADVOCATING • GIVING BACK



**LAND O' LAKES**  
ANIMAL MILK SOLUTIONS

Farmer-Owned  
**LAND O' LAKES**

  
**PURINA**

**CROPLAN**  
By WINFIELD  
UNITED

**Alltech**

JOIN US FOR A

## HAPPY HOUR

Please join us at the **Sheraton Hotel Bar** for complimentary beverages before the Central Plains Dairy Expo Welcome Reception!

**Water's Edge Lounge**  
**Tuesday, March 25<sup>th</sup>**  
**3:30-5:00 p.m.**

Visit Alltech at **Booth #C415** at Central Plains Dairy Expo!



## FROM DATA TO IMPACT: MAXIMIZING DRY MATTER INTAKE FOR OPTIMAL PERFORMANCE

WEDNESDAY & THURSDAY

*Ron Van Beek*

CEO & Founder of Van Beek Natural Science

Join Ron Van Beek at his hands-on session to explore the **direct impact of feed intake on your operation!**

**VAN BEEK**  
NATURAL SCIENCE

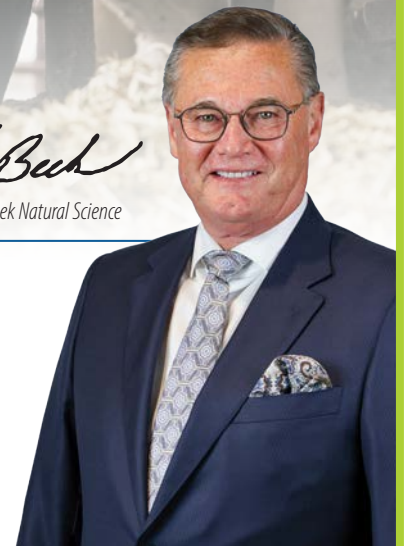

# NEW PRODUCTS!

## PHIBRO ACQUIRES ZOETIS' MEDICATED FEED ADDITIVE BUSINESS

217-577-9761

[vernon.metcalf@pahc.com](mailto:vernon.metcalf@pahc.com)

<https://www.pahc.com>

Phibro Animal Health Corporation completed the acquisition of the medicated feed additive portfolio and certain water-soluble products from Zoetis, Inc. This marks a significant step in furthering Phibro's purpose to optimize global animal health and nutrition for better lives and a more sustainable world. With this acquisition, Phibro is expanding its offerings across cattle, swine and poultry with a portfolio of more than 37 product lines sold across approximately 80 countries – enhancing the company's worldwide reach and capabilities. These new products complement Phibro's existing lineup of medicated feed additives, vaccines, mineral nutrition and nutritional specialty products, helping deliver even more comprehensive solutions to customers and ensure that food is produced safely and sustainably. Learn more about Phibro's expanded solutions by visiting Phibro reps on the trade show floor or the website at: [pahc.com/new-products](https://pahc.com/new-products).

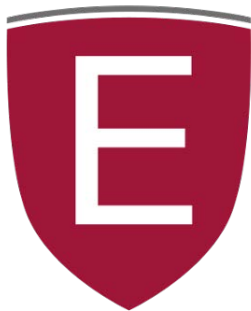

Elife®

Natural cell protection

### ELIFE

Feedworks USA

513-271-4120

[Tom.Elliott@feedworksusa.com](mailto:Tom.Elliott@feedworksusa.com)

<https://www.feedworksusa.com>

Feedworks USA introduces Elife, a natural blend of various EU-sourced polyphenols designed to replace the antioxidant power of vitamin E, reducing feed costs. Its powerful antioxidant capacity supports oxidative stress management in high-producing dairy cows. The antioxidant power of Elife has been validated through ICOS and ORAC assays, and can be easily integrated into feed formulations.

### CHOLIGEM

Kemin Animal Nutrition and Health

765-309-1612

[jared.bramer@kemin.com](mailto:jared.bramer@kemin.com)

<https://www.kemin.com/choligem-us>

Kemin launched CholiGEM, an advanced rumen-protected choline supplement for lactating dairy cows, in the U.S. market. Choline supports milk production, reproduction and health, especially during the transition period. CholiGEM, with 60% choline chloride, enhances liver function, energy use, lactation performance and immunity, while reducing fatty liver risks and ketosis occurrences.



# NEW PRODUCTS!

## MITIGATE STRAY VOLTAGE AND ELECTRICAL NOISE

Zero Tolerance

605-770-9131

[joey@currentdefense.com](mailto:joey@currentdefense.com)

<http://www.zerotolerance.tech>

Zero Tolerance announced the approval of products that meet the company's strict standards, ensuring reduced stray voltage or electrical noise. Look for the Zero Tolerance Approved sticker, which signifies improvements in animal welfare, increased milk production and enhanced farm efficiency. Visit us during Central Plains Dairy Expo to learn more about the approved products.

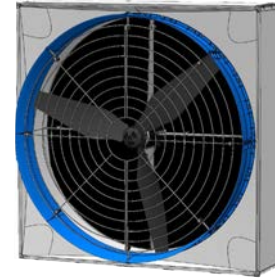

## NEW OPEN AIR SIDE PANELS

Agri-Plastics

678-983-9192

[steveb@agri-plasticsgroup.com](mailto:steveb@agri-plasticsgroup.com)

<https://calfhutch.com>

Agri-Plastics introduces its new side panels with wire inserts for the Ultra Flex and Open Air Pen systems. These innovative panels enhance calf welfare by encouraging socialization and reducing stress – allowing calves to see and interact with each other while maintaining individual care. They also improve airflow and ventilation – making them a game-changer for calf comfort and well-being.

## BOVAER

Elanco Animal Health

317-518-7433

[bradley.nicholson@elancoah.com](mailto:bradley.nicholson@elancoah.com)

<https://creditforgood.com>



Elanco announced that the U.S. Food and Drug Administration (FDA) completed review of Bovaer – the first-in-class methane-reducing feed ingredient for the U.S. dairy industry. FDA confirmed that Bovaer meets safety and efficacy requirements. Bovaer provides dairy producers with an opportunity for a diversified income stream that is not dependent on milk markets: the carbon marketplace. At the forefront of the industry, Bovaer reduces enteric methane emissions by approximately 1.2 metric ton carbon dioxide equivalent per lactating dairy cow per year. Bovaer has no negative impact on the quantity or quality of milk produced.



# NEW PRODUCTS!

## POWERED COW BRUSH

VES-Artex

785-331-6428

[jared.bronaugh@ves-artex.com](mailto:jared.bronaugh@ves-artex.com)

<https://ves-artex.com>

Encourage hygiene, milk production and environmental enrichment for your herd with a powered cow brush from VES-Artex. It automatically rotates when a cow engages with it and can rotate clockwise and counterclockwise – ensuring that the cow's tail doesn't get stuck. The rocking motion allows the brush to reach where a static brush can't. The bristles lead the industry with their durability.



5-STAR

*When scouring events occur...*

# Count on Mom.

Delivering a synergy of bioactives sourced from mom's colostrum with researched electrolyte technology, new Replenish Ab+ accelerates a calf's ability to overcome scouring events. Support gut balance, bring electrolyte correction, and mitigate the severity and duration of scouring.

BLUELITE<sup>®</sup>  
**ReplenishAb+**  
by TechMix

[ReplenishAb.com](https://ReplenishAb.com)



877-466-6455

**TechMix** Keeping animals drinking, eating & producing.<sup>™</sup>

# LODGING

There are plenty of lodging options in Sioux Falls. A handy online guide to area hotels is located on the Convention and Visitors Bureau website at [www.visitsiouxfalls.com/places-to-stay/hotels-and-motels](http://www.visitsiouxfalls.com/places-to-stay/hotels-and-motels). The following is a partial list of hotels. However, being listed does not imply availability or an endorsement by the Central Plains Dairy Expo. For more Expo information go to our website.

## Visit [CentralPlainsDairy.com](http://CentralPlainsDairy.com)

### **Sheraton**

(605) 331-0100  
1211 N. West Ave.  
Sioux Falls, SD 57104

### **Fairfield Airport by Marriott**

(605) 339-8997  
4035 North Babhalla Dr.  
Sioux Falls, SD 57107

### **Home2 Suites by Hilton**

(605) 332-5461  
1120 S Grange Ave.  
Sioux Falls, SD 57104

### **AmericInn by Wyndham Sioux Falls North**

(605) 339-8997  
3300 W Russell St  
Sioux Falls, SD 57107

### **Country Inn & Suites by Radisson**

(605) 373-0153  
200 East 8th St.  
Sioux Falls, SD 57110

### **Best Western Ramkota Hotel**

(605) 336-0650  
3200 W. Maple St.  
Sioux Falls, SD 57107

### **Ramada Inn & Suites Airport**

(605) 336-1020  
1301 W. Russell St.  
Sioux Falls, SD 57104

### **Quality Inn & Suites**

(605) 336-1900  
5410 N. Granite Ln.  
Sioux Falls, SD 57104

### **Holiday Inn Airport**

(605) 331-2040  
2040 W. Russell St.  
Sioux Falls, SD 57104

### **Holiday Inn City Center**

(605) 339-2000  
100 West 8th St.  
Sioux Falls, SD 57104

### **Guest House Inn and Suites**

(605) 338-6242  
3101 W. Russell  
Sioux Falls, SD 57107

### **Motel 6**

(605) 336-7800  
3009 W. Russell  
Sioux Falls, SD 57107

### **Sleep Inn**

(605) 339-3992  
1500 N. Kiwanis Ave.  
Sioux Falls, SD 57104

### **Staybridge Suites**

(605) 361-2298  
2502 S. Carolyn Ave.  
Sioux Falls, SD 57106

### **Hampton Inn Sioux Falls North**

(605) 362-1700  
2417 S. Carolyn Ave  
Sioux Falls, SD 57106

### **TownePlace Suites by Marriott North**

(605) 361-2626  
4545 W. Homefield Dr.  
Sioux Falls, SD 57106

### **Hampton Inn and Suites SW Sioux Falls**

(605) 271-0992  
3701 Avera Dr.  
Sioux Falls, SD 57108

### **Hotel On Phillips**

(605) 274-7445  
100 North Phillips Ave.  
Sioux Falls, SD 57104

### **Canopy by Hilton Sioux Falls Downtown**

(605) 275-4120  
120 E 4th Place  
Sioux Falls, SD 57104

# CONVENTION CENTER

## Denny Sanford Premier Center

1201 Northwest Avenue, Sioux Falls, SD 57104

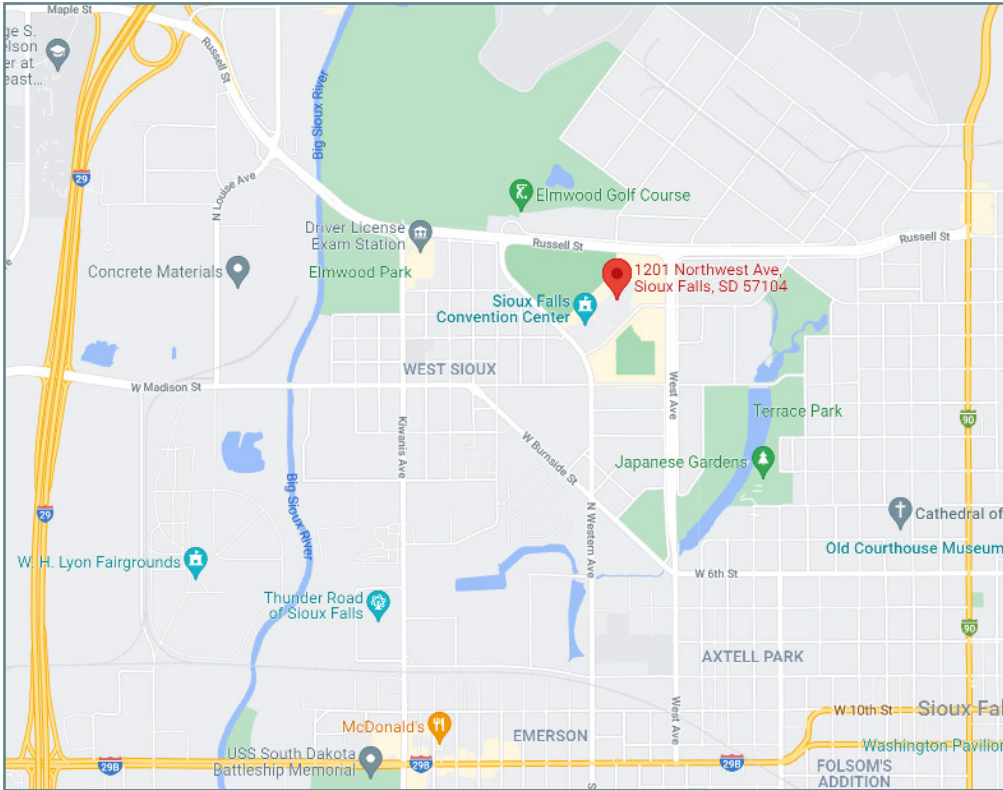

The Central Plains Dairy Expo is easy to reach. It is held in the Denny Sanford Premier Center, which is located in Sioux Falls, SD, south of the junction of Interstates 90 and 29. Take I-29 Exit 81 east and follow the signs to the Sanford Premier Center. It is 1-¾ miles east of the interstate. The address is 1201 Northwest Avenue, Sioux Falls, SD.

## Register in advance!

AVOID LINES & EXPEDITE  
GETTING YOUR BADGE

[www.CentralPlainsDairy.com](http://www.CentralPlainsDairy.com)

USE THE HASHTAG  
**#CPDE2025**



# 5 STAR SPONSORS



# 5 STAR SPONSORS

*Farmer-Owned*



# 4 STAR SPONSORS



MIDWEST DAIRY SOLUTIONS

novonesis

# 3 STAR SPONSORS



# 2 STAR SPONSORS

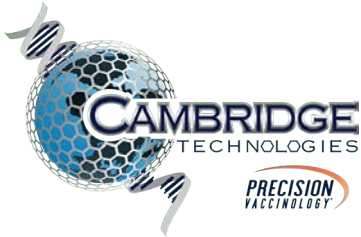



# 1 STAR SPONSORS

- 4-D AG World/4-D AG Fashion
- A1 Development Solutions
- ABS Global
- Ag Property Solutions
- Ag Tech Business
- Agri-Plastics/Agri-Comfort
- AgriSteel USA
- Agromatic, Inc.
- Agropur, Inc.
- Amelicor
- Anez Consulting, Inc.
- Archer Daniels Midland Company
- Arnolds of Kimball, Inc.
- BECO Dairy Equipment
- Bio-Vet Inc.
- Bovine Hoof Adhesives/Glue-U Inc.
- Butler Machinery Company
- Calf-Tel
- Countryside Dairy Solutions
- Dairyland Laboratories
- DairyVisor, Inc.
- DBC Ag Products & LIRA GOLD Supplements
- Dellait - Animal Nutrition & Health
- Development Resources of Iowa, Inc.
- Diamond V
- ENDOVAC Animal Health
- Faber's Farm Equipment
- Farm Inc.
- GENEX
- Hawke & Company Ag
- Herd-Boss/Post Equipment Company
- Hover Chute
- Iowa Area Development Group
- J & D Manufacturing
- Jones-Hamilton Co.
- Kooima Ag
- Lange Ag Systems, Inc.
- Legend Rubber Inc.
- Maas Energy Works
- MB Nutritional Sciences, LLC
- MEDA/Chemstar & Milk-Rite USA
- milc Group
- Minnesota Department of Agriculture
- MTech Dairy Solutions
- Norbco
- NovaMeal by Novita Nutrition
- Novus International
- NuAge Builders
- Nuhn Industries Ltd.
- Parnell Living Science
- PEAK Forage Solutions Inc.
- Pioneer Seeds
- QualiTech, LLC
- Real-Tuff, Inc.
- Safe-Trac Grooving
- smaXtec Inc.
- Steuart Labs
- TranSource Truck & Equipment Inc.
- Udder Comfort Inc.
- Udder Health Systems
- Udder Tech Inc.
- Valley Queen Cheese
- VES-Artex
- Vetagro Inc.
- Zero Tolerance/Current Defense



Thank you to all  
our sponsors!

# EXHIBITORS

<b>A</b>	
4-D AG World/4-D AG Fashion	C810
A1 Development Solutions	H109
A1 Mist Sprayers	A513
ABS Global	C306
ADA Enterprise Inc.	A512
Adisseo	C328
Advanced Ag Products	C804
Afimilk	A306
Ag Processing, Inc.	C628
Ag Property Solutions	C706
Ag Tech Business	AF109
Agri Feed International, LLC	C407
Agri-King, Inc.	C404
Agri-Placement Services, Inc.	A103
Agri-Plastics/Agri-Comfort	C724
AgriSteel USA	C301
AgroChem USA, LLC	C703
Agromatic, Inc.	C704
Agropur, Inc.	C122
AHV USA	C112
Albers Dairy Equipment, Inc.	C507
Alltech	C415
Amelcor	H113
American AGCO Trading Co.	C629
American Dairymen/Twin Rivers Media	C128
AMPI	A400
Anez Consulting, Inc.	C633
Animal Health International	C530
Animat Inc.	A1011
Archer Daniels Midland Company	C632
Arm & Hammer Animal Nutrition	H102
Armor Animal Health	C228
Arnolds of Kimball, Inc.	C433
Artex Manufacturing	A406
Aurora Pharmaceutical	A1109
Axiota Animal Health, Inc.	H111
<b>B</b>	
Balchem Corporation	C527
Beck's	A413
BECO Dairy Equipment	H110
Bio-Vet Inc.	H123
Boehringer Ingelheim	C310
BouMatic	C232

Bovine Hoof Adhesives/Glue-U Inc.	A219
BoviSync	A1107
Butler Machinery Company	A803
Byron Seeds, LLC	H132
<b>C</b>	
Calf Care & Quality Assurance, National Dairy FARM Program	A1210
Calf Star	A1113
Calf-Tel	C400
CalfStart LLC	H122
Cambridge Technologies	C309
Central Confinement Service LLC	A108
Central Life Sciences	M
Central Plains Lely Centers: Gorter's Clay & Dairy Equipment; Leedstone; Automated Dairy Specialists NE	C318
Central Valley Dairy Supply Inc.	A402
CHS	C308
CIH/Commodity & Ingredient Hedging, LLC	C113
Cloverdale Equipment LLC	A800
Comfort Hoof Care	A1214
Conewango Products Corp.	U
Control Solutions Inc.	A1013
Corteva Agriscience MCS, LLC - Dairyland Seed	A600
Countryside Dairy Solutions	C304
CowManager	A211
CRV USA	A1112
Crystal Creek Natural	A209
Cumberland Valley Analytical Services	H127
<b>D</b>	
Dairy Coach, LLC DBA PeopleCor	A107
Dairy Farmers of America	AF102
Dairy Star	C220
Dairyland Laboratories	C604
DairyVisor, Inc.	C307
Dakota Fluid Power	A1215
Dakota Iron Equipment	Outside
Datamars Livestock	A116
Dave's Repair	C818
DBC Ag Products & LIRA GOLD Supplements	A1103
DeHaan, Grabs & Associates, LLC	C835
Delaït - Animal Nutrition & Health	C100 & B

# EXHIBITORS

Deluxe Animal Health	C610 & C
Development Resources of Iowa, Inc.	C700
Diamond V	C402
Diesel Machinery Inc.	C828
DLF	C324
DM Concrete Grooving	Z
Doda USA	A1003
Dordt University	L
<b>E</b>	
EASYFIX Livestock Comfort	C731
EBJ Livestock Market Inc.	A214
Edge Dairy Farmer Cooperative	C330
Elanco Animal Health	C427
Elite Plastic Products, A Division of AmeriLux International	A1104
ENDOVAC Animal Health	C200
Equipment Blades	A315
Essential Water Solutions, Inc.	A405
Ever.ag	C300
Everlast Industries	C808
Evolution Spray Foam	A309
Excel Machine & Mfg	C901
Extrutech Plastics	A106
<b>F</b>	
Faber's Farm Equipment	C121
FAMO Feeds, Inc.	C702
Farm Inc.	C609
Farm Systems	C313
FarmFirst Dairy Cooperative	C734
Feedworks USA, Ltd.	C511
FERA Diagnostics and Biologicals Corp.	C327
Forage Genetics International	C607
Form-A-Feed, Inc.	C134
Frontier Mills Inc.	H125
<b>G</b>	
GEA Farm Technologies Inc.	C618
GENEX	C101
Gingerich Structures, LLC	A1213
Golden Calf Company	C430
Gorter's Clay & Dairy Equipment of MN, Inc.	C521
<b>H</b>	
Hanson Silo Company	C518
Hatfield Mfg. Inc.	C902
Hawke & Company Ag	C824

Heart of America DHIA	H126
Heartland Builders Co.	C609
Herd-Boss/Post Equipment Company	C826
Hoard's Dairyman	G
Hoof-Zink	A1207
Hoppe Roofing Inc.	E
Hover Chute	C509
Hubbard Feeds Inc.	C115
Hundertmark Cleaning Systems, Inc.	A511
<b>I</b>	
I-29 Moo University Collaboration	A203
Iowa Area Development Group	C605
<b>J</b>	
J & D Manufacturing	C905
J. B. Hunt Ag Services	X
JDJ Solutions	A115
Jefo Nutrition USA Inc.	H135
Johnson Concrete Livestock Waterers	C904
Johnson Engineering Group, LLC	A1108
Jones-Hamilton Co.	A1014
<b>K</b>	
K2S Engineering Inc.	C800
Kemin Animal Nutrition & Health	C209
Kooima Ag	C626
Kuhn North America	C822
Kundfin "the insectary"	A1105
<b>L</b>	
Lallemand Animal Nutrition	C208
Land O' Lakes/Purina/Croplan	C215
Landmark Builders	A510
Lange Ag Systems, Inc.	A902
Lankota	A607
Lawley's Inc.	A303
Leedstone	C321
Legend Rubber Inc.	AF105
<b>M</b>	
Maas Energy Works	A802
MAI Animal Health	A505
Marsh McLennan Agency	C411
MB Nutritional Sciences, LLC	H100
McFinn Technologies	A1012
McLanahan	C111
MEDA/Chemstar & Milk-Rite USA	AF100

# EXHIBITORS

Medgene	A109
Mensch Mfg	C613
Merck Animal Health	C206
MGK Insect Control Solutions	C602
Micro Technologies and MWI Animal Health	C832
Midwest Dairy	C204
Midwest Dairy Solutions	C230
Midwest Livestock Systems, LLC	C624
Midwest Sidewalls	A415
milc Group	C630
Minnesota Department of Agriculture	C303
MN DHIA (MN Dairy Herd Improvement Assoc.)	AF104
MTech Dairy Solutions	C326
Munters	C935
<b>N</b>	
NDEco / New Direction Equipment Co.	A603
Nebraska State Dairy Association	N
Neogen	H
Norbco	C830
North Central Steel Co.	A307
Northern Plains Forage Association	Q
Northland Farm Systems	A1003
NovaMeal by Novita Nutrition	C331
Novonosis (formerly Chr. Hansen)	C114
Novus International	C603
NuAge Builders	H133
Nuhn Industries Ltd.	A619
NutraDrip Irrigation	C510
Nutrient Advisors	Y
<b>O</b>	
Osakis Silo Repair DBA: WW Erection	C728
OZOLEA RETE AGRICOLA	T
<b>P</b>	
Parnell Living Science	A602
PEAK Forage Solutions Inc.	C730
Phibro Animal Health	C221
Pifer's Auction & Realty	A1008
Pioneer Seeds	H101
POET	A412
Polytank Inc.	A213
Poseidon, LLC	A1111
Post Equipment Company/Herd-Boss	C424

PowerLift Doors by Rick's Welding	A414
Prairie Farms Dairy	A305
Prairie Land Ag Supply, Inc.	C235
ProfitPro Ag	A206
Progressive Dairy	H115
Promat	A310
PSI Power Washer	P
Puck Enterprises	A1203
<b>Q</b>	
QualiTech, LLC	C520
QualiTru Sampling Systems	A1010
Quality Liquid Feeds, Inc.	C213
<b>R</b>	
Ralco	C409
RDO Equipment Co.	A806
Real-Tuff, Inc.	C302
ReproScan	A105
Ridgewater College	A
Rippleview Hoof Care, Ltd.	A204
RMH Jones Equipment	A1110
<b>S</b>	
Safe-Trac Grooving	C908
Scherer Inc.	C502
Schwartz Manufacturing	A1106
SDSU, College of Ag, Food & Environmental Science	K
Select Sires Member Cooperative	C119/ H114
Sharp Industries	C809
SIDUMP'R Trailer/The BatchBox	A104
Silostop Agri	I
Sioux Dairy Equipment	C615
Sioux Nation Ag Center	F
SKOV-SECCO	A612
smaXtec Inc.	C932
South Dakota Dairy Producers	BB
South Dakota, Governor's Office of Economic Development	A1206
Soy Best	C226
Specialty Sales, LLC	A111
Steelwerx, LLC	C806
Steuart Labs	C600
STgenetics	C224
Straight Arrow Energy, LLC	A1212

# EXHIBITORS

Sun-North Systems, Ltd.	A314
Superior Attachments Inc.	V
Supervisor Systems	C211
Syngenta Enogen	A110
<b>T</b>	
TechMix, LLC	C109
TerraKat LLC	A208
The Coburn Company Inc.	A113
TLAY Dairy Video Sales	C124
Topcon Agriculture	A410
Trans Ova Genetics	C534
TranSource Truck & Equipment Inc.	A615
Tri-State Neighbor	H107
Trioliet B.V.	C332
<b>U</b>	
Udder Comfort Inc.	AF110
Udder Health Systems	C631
Udder Tech Inc.	C126
United Animal Health	C202
<b>V</b>	
V & M Company, Inc.	C802
Valley Dairy Farm Automation Inc.	C635
Valley Queen Cheese	H128
Van Beek Natural Science	C504
Van Bruggen & Vande Vegte, PC	H108
Van Zee Enterprises Inc./Rock Valley Pre-cast	S
VAS	C103
Vaxxinova	C528
VES-Artex	C531
Vetagro Inc.	C708
Vita Plus Corp.	C107
Vosterman's Ventilation	A1205
<b>W</b>	
Westway Feed Products	AF107
Wieser Concrete Products Inc.	C729
<b>Y</b>	
Y-TEX Corporation	AA
Ymker Insulation Inc.	A304
<b>Z</b>	
Zero Tolerance/Current Defense	C930
ZISK App, LLC	H120
Zoetis Animal Health	C218

**Agricultural Programming**  
Market Reports ▪ Market Analysis ▪ Ag News  
**3 times every hour**  
Farm Director Keith Lundberg

**RADIO 570**  
**WMAX**

**DON'T FORGET!**

- Register online in advance
- Expedite your badge
- Download CVENT Events mobile app
- Mark your calendars for upcoming events

**CENTRALPLAINSDAIRY.COM**

# CONVENTION CENTER

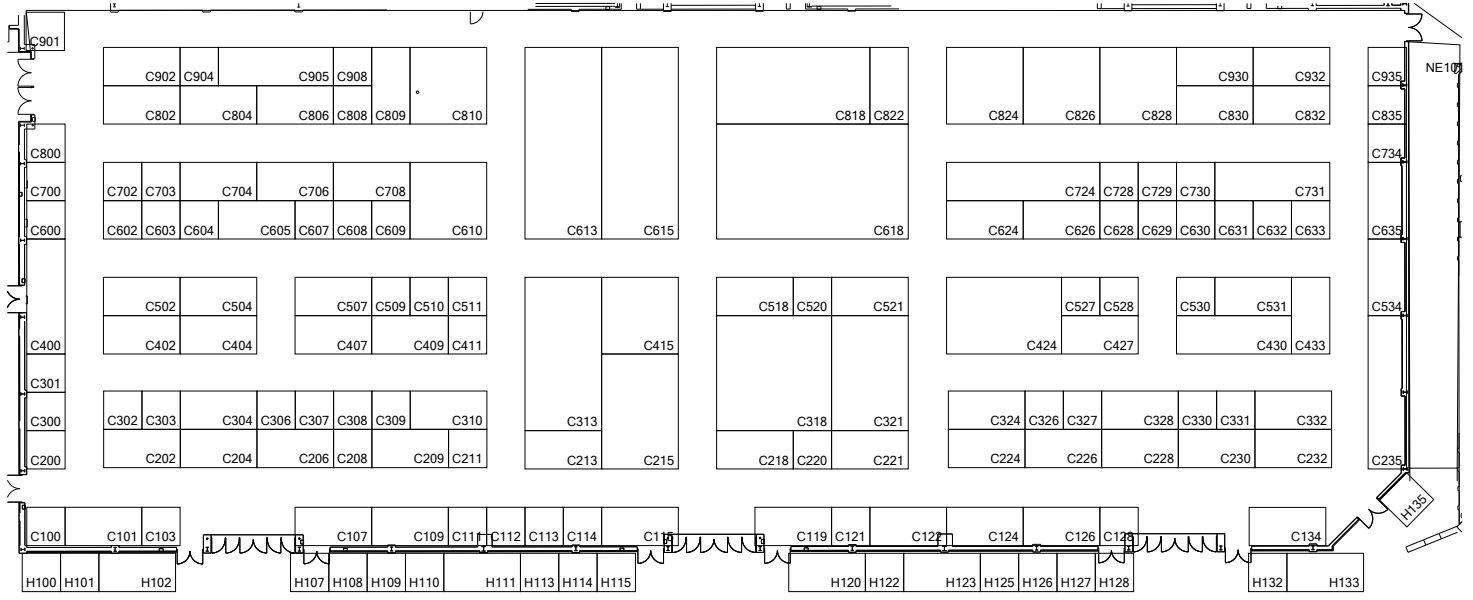

ⓐ A B ⓑ C ⓓ E F ⓔ G H ⓖ I ⓗ K L ⓙ M ⓚ N ⓛ P Q ⓜ S ⓞ T U ⓟ V ⓠ X Y ⓡ Z AA ⓢ BB

# ARENA

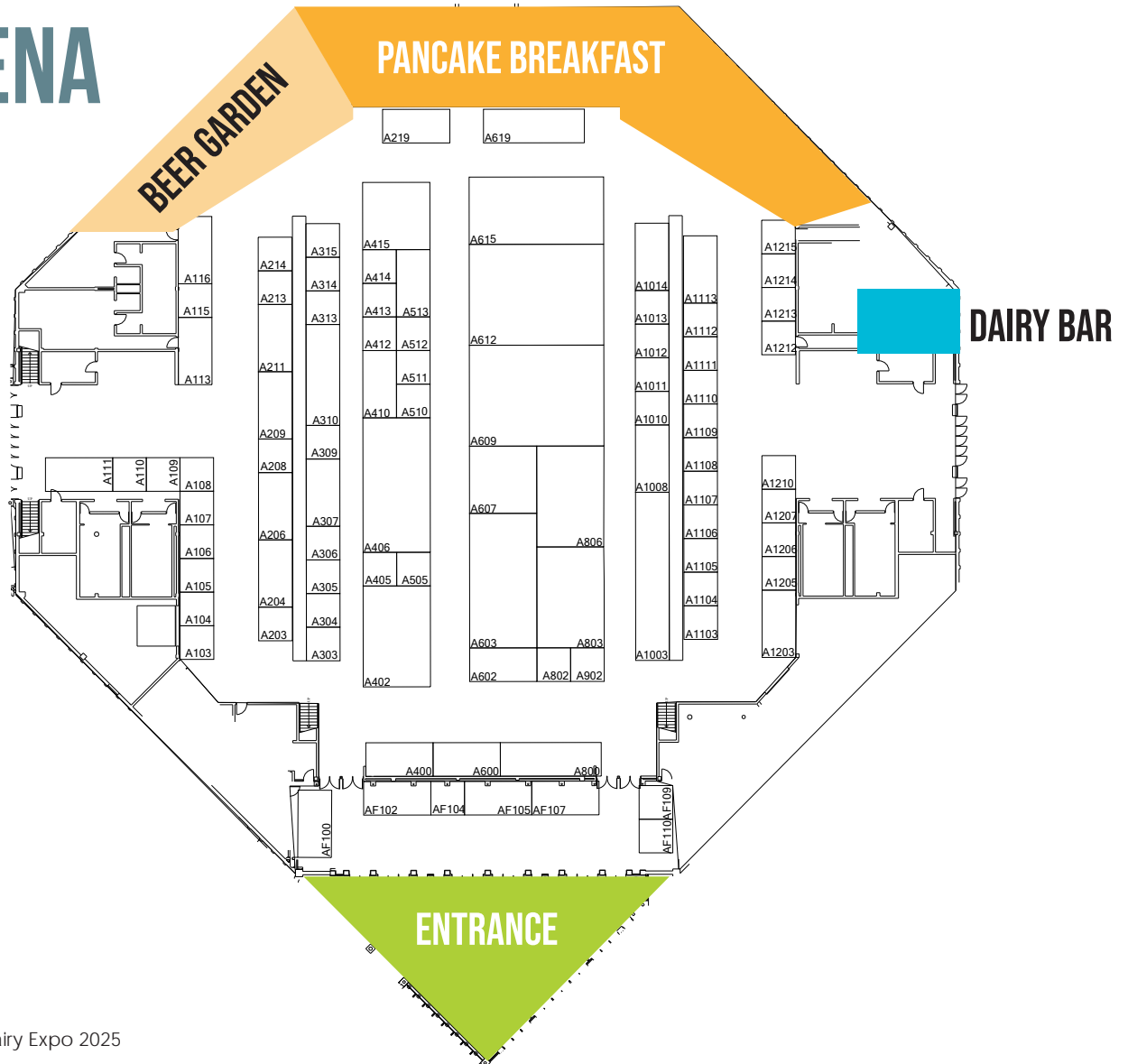

# It all comes down to the milk.



## Your Milk Can Be More.

Milk is the lifeblood of your dairy and its quality is the measure for your success. From genetic insights to real-time, on-the-ground expertise, Zoetis offers comprehensive, flexible milk quality solutions for your herd. **Zoetis can help you get more from your operation, so you can get more from your milk. [MilkCanBeMore.com](https://www.MilkCanBeMore.com)**



126 Main Street West  
New Prague, MN, 56071

**2025 EXPO**  
MARCH 25-27

ANYTHING BUT TYPICAL.



# CROPLAN<sup>®</sup> ALFALFA. HERE TO STAY.

With Dairyland and Pioneer alfalfa saying goodbye, you might be looking for a new alfalfa seed to try. CROPLAN alfalfa is committed to offering high-end germplasm loaded with the latest trait technology for alfalfa growers.

See your leading crop input retailer and ask for CROPLAN seed today.

[CROPLAN.COM](http://CROPLAN.COM)

